

**Get There
By Bike!**



← Downtown via quiet r

**Wayfinding Guidelines for Utility Cycling
in Metro Vancouver**

Version 1.1 September 2013

Contents

1.0	Introduction	3
1.1	Context	4
1.2	Scope	6
1.3	Principles	8
1.4	Destinations	10
2.0	Regional Wayfinding System	13
2.1	Sign family	14
2.2	Decision sign	16
2.3	Confirmation sign	18
2.4	Turn Fingerboard	20
2.5	Off-network Waymarker	22
2.6	Alternatives and enhancements to signs	24
3.0	Design Guidance	27
3.1	Wayfinding strategy	28
3.2	Sign planning	33
3.3	Site assessment	36
3.4	Sign design	39
Appendices		
1	Regional Bicycle Wayfinding Destination Schedule	72
2	Route Naming Advice	85
3	Specific Situations – worked examples	87
4	Summary of Bicycle Wayfinding Best Practice Review	105
5	Template Guide	119



Destination I

Destination II

via quiet route

Destination III

1.0 Introduction

Explaining the purpose, benefits and background to the regional bicycle wayfinding guidelines

1.1	Context	4
	The Regional Cycling Strategy.....	4
	Relationship to existing guidance.....	4
	What are the benefits of wayfinding?.....	5
	How these guidelines were developed.....	5
1.2	Scope	6
	Identifying the user.....	6
	Wayfinding for walking.....	6
	Prioritizing routes for wayfinding signage.....	7
	Other trip planning support.....	7
	Other types of information.....	7
1.3	Principles	8
1.4	Destinations	10
	Destination hierarchy.....	10

1.1 Context

The Regional Cycling Strategy

These guidelines form one of the actions described in the Metro Vancouver Regional Cycling Strategy, ‘Cycling for Everyone’, published in June 2011.

The goals of Cycling for Everyone are to increase cycling as a choice for journeys where it is already competitive i.e. those journeys of 8 km or less. If successful, thousands more people will be starting to cycle to work, to school, and for other normal journeys over the next three decades. The strategy aims to ensure that many of these journeys can be on cycle routes that are comfortable for most, if not all levels of experience.

One of the components of a comfortable network is provision of good quality signage to guide new users to their destinations. Strategy 1.5 of Cycling for Everyone, describes the ways to ‘Make the bikeway network easy to navigate’ and commits to developing a common regional wayfinding system for cycling.

Relationship to existing guidance

These guidelines are intended to provide advice and designs for bicycle wayfinding across Metro Vancouver. Other types, including warning and regulatory signs are covered by the Transportation Association of Canada (TAC) and BC Ministry of Transportation and Infrastructure (BC MoTI).

The current edition of the TAC Bikeway Traffic Control Guidelines for Canada provides specific guidance on signage and markings for bicycle facilities. Similar guidelines from the BC MoTI are forthcoming.

This document supplements these national and provincial guidelines providing additional advice, details and solutions to circumstances common to Metro Vancouver.

In addition to Canadian references, there is a range of compatible advice available from the United States. While practitioners must be careful not to contradict applicable Canadian guidelines the following may be of interest:

- US National Association of City Transportation Officials (NACTO) Urban Bikeway Design Guide
- American Association of State Highway and Transportation Officials (AASHTO) Guide for the Development of Bicycle Facilities

Regional Cycling Strategy goals

Goal 1

More people cycle more often so that, by 2040, 15% of all trips less than 8 km are made by bicycle

Goal 2

Cycling feels safer so that by 2040, 50% of all cycling trips are made by females. Cycling is safer so that by 2040, 50% fewer people are killed or seriously injured while cycling.



What are the benefits of wayfinding?

Wayfinding is a decision making process related to navigation. The decisions we make are influenced by what we sense, our experience and the information we can obtain. Signage, maps and increasingly mobile devices, are commonly recognized types of wayfinding information.

Cycling remains a minority mode of transportation, but it is an efficient, economical and sustainable choice for many journeys. TransLink estimate that 650,000 of the 5.4 million motorized trips in the region could realistically be switched to cycling¹.

Many of these potential cycling trips could be made by people new to cycling. For them the wayfinding process will be more conscious as they will not know the bike network or understand what journeys they are capable of riding.

Much of the region's hundreds of kilometers of bikeways are on residential streets, separated paths or on special routes that a driver or transit user might be unaware of. This network can provide safe, comfortable and convenient access across the region but only if cyclists can find their way to it and use it.

A wayfinding system can help users by identifying the bike network, pointing out route options and helping them learn what other journeys could be ridden.

How these guidelines were developed

The guidelines were prepared by TransLink in consultation with the municipal representatives who attend the Bicycle Subcommittee of the Major Roads Technical Advisory Committee.

The Bicycle Subcommittee members contributed comments, questions and recommendations at various stages in the writing of the guidelines.

The Wayfinding Guidelines for Utility Cycling in Metro Vancouver will be reviewed and updated from time to time to ensure that they remain compatible with current guidance produced by other bodies. The Bicycle Subcommittee members will be involved in this process to ensure that the guidelines remain consistent and appropriate for the needs of the municipalities responsible for delivering cycling projects across the region.

The regional cycling strategy for Metro Vancouver sees a common wayfinding system as a part of its vision for a Bicycle Transportation Network.



1.2 Scope

Identifying the user

These guidelines are focused on helping achieve the goals of the regional cycling strategy. In particular, they aim to support a mode shift towards cycling for trips that would otherwise be taken using less sustainable modes.

The wayfinding guidelines accommodate this focus by prioritizing directions to places that many people visit for a wide variety of purposes, that are a moderate distance apart and those that can be accessed from the designated bike network.

By implication the guidelines are not specifically intended for recreational cycling, which includes cycling on trails, cycle sports or long distance touring, since these do not directly encourage mode shift. However, TransLink acknowledges the value of information for recreation and other uses, such as cycle tourism as part of a supportive framework. The guidelines therefore include principles and advice that may be a useful reference for trail signage or other non-utility cyclist wayfinding.

Wayfinding for walking

Walkers and cyclists have very different needs when wayfinding.

A cyclist can travel much further and faster than a walker for the same effort. This produces large differences in how far away a destination might be reasonably signed from. Walkers are also more willing to stop and study information, whereas maps, detailed directions and smaller text are difficult to use while cycling. As with driving, to safely manage the information load, a bicycle wayfinding system must be simple and refrain from including too much text on any one sign.

For these reasons the guidelines do not attempt to combine cycling and walking wayfinding in a single approach. However, the presence of cycling wayfinding on shared paths will undoubtedly provide some benefits to walkers. This could be supplemented by maps and specific directions to local destinations within short, walkable distances.

Types of cyclist



Utility cycling

Some people use the network to get to work or other specific purposes. They need consistent, reliable information for their whole journey.



Recreational cycling

Some people use the network for fun or exercise and with no specific destination. They may look for contextual information and directions to services.



Cycle tourism

An increasing number of people travel by bike for vacations. They will have a route plan, but may look for places to explore before returning to their journey.

These guidelines focus on routes suitable for utility cycling but wayfinding may be helpful for other types of cycling

Principle 6 Help Users Learn

Help new or returning cyclists learn how to navigate the designated cycling network for regular or new journeys. (See page 9 for principles.)

Prioritizing routes for wayfinding signage

While it is possible to cycle on most streets, a network of designated cycling routes has evolved that represent streets and paths with specific facilities for cycling. This network of designated cycle routes across Metro Vancouver is the primary focus of the wayfinding guidelines.

However, the network is very large and varies considerably in terms of facilities, traffic use and suitability for different levels of cycling experience. Therefore, planners need to determine which specific routes they wish to sign and to agree with their neighbouring authorities when routes extend across boundaries.

Over time a Major Bike Network (MBN) including the Central Valley Greenway, BC Parkway and North Shore Spirit Trail will be developed as part of TransLink's 2011 Regional Cycling Strategy. The MBN will become a strategic transportation system connecting all the region's urban centres. The MBN should be a priority for wayfinding.

At a municipal level, there are a number of locally important cycle routes that connect local communities. These form the majority of the existing well-used bicycle network and will provide major links to the MBN. These routes may be early candidates for wayfinding.

Finally, there are also some less heavily-used routes that connect neighbourhoods, schools, parks and places of work. These routes will have different importance in local transportation plans and may be suitable for wayfinding to promote local cycling targets or meet specific needs.

Other trip planning support

These wayfinding guidelines concentrate on one part of the wayfinding process: directions to help someone who is already out on their bike. However, new cyclists may also be interested in planning their route, looking for alternatives or researching other journeys that they could make by bike. Below are some other tools that cyclists can use, or municipalities can provide, that complement the on-street wayfinding signage described in these Guidelines.

TransLink and many municipalities produce cycle route maps, some of which are free. UBC maintains a free online cycle planner with support from TransLink and the City of Vancouver (www.cyclevancouver.ubc.ca). Advocacy groups such as HUB (formerly the Vancouver Area Cycling Coalition) provide free advice on journey planning, and there is a growing range of commercial journey planning and tracking options that may be useful to cyclists.

Route maps and local information is also found on some routes. Information kiosks, area maps and local information can help encourage use and provide a valuable resource if someone is feeling lost.

Longer cycling journeys are often made with a transit stage. Information about walking and cycling options from transit facilities is being rolled out across the region under TransLink's wayfinding program. TransLink facilities provide an important role in supporting the cycling network and increasingly, wayfinding information nodes.

Other types of information

Wayfinding is just one type of information that may be directed at cyclists. Municipalities may also wish to provide interpretive signage, recognize corporate sponsors, or identify volunteer groups who maintain bikeways. These and other types of non-wayfinding information should be provided separately so that wayfinding guidance is always easy to identify and understand.

1.3 Principles

These Guidelines will be formulated around a set of core design principles. These principles are included to describe the basis for ensuring a fundamentally consistent approach to every solution.

The principles proposed below are derived and adapted from the principles underlying the TransLink Wayfinding Standards Manual (TWSM) which has been adopted as the standard for all transit facility wayfinding in Metro Vancouver. Deriving principles from the TWSM enables consistency for intermodal facility design and extends a tried and tested methodology.



1 Connect places

The regional cycling strategy aims to encourage new cyclists to undertake everyday journeys by bike. Wayfinding information should help people ride between destinations and develop an increased sense of how cycling can provide mobility.

The relationship between the bicycle network and the principle of connecting places also helps inform future planning priorities.



2 Use consistent names

The consistent use of an agreed list of names and references allows for users to confidently use wayfinding signage to reach destinations and follow routes across different jurisdictions.

A consistent set of references also helps users trust and learn the system and so apply their knowledge to new journeys.



3 Maintain movement

Cycling is a physical activity and repeated stopping and starting is both tiring and frustrating. Wayfinding information that cannot be read quickly by cyclists at desired travel speeds makes bicycle journeys less attractive.

Continuous, visible and clear wayfinding will help identify routes and enable cyclists to maintain an even pace.



4 Be predictable

When information is predictable it can be quickly recognized, understood and used. Predictability can relate to all aspects of wayfinding information, from the placement of a sign to the design of its contents.

Predictability also means that understanding can be recalled for use in new situations. Once riders trust that they will encounter consistent and predictable information, new journeys can be made more easily.



5 Disclose information progressively

It is important to provide information in manageable amounts when wayfinding. Too much information can be difficult to understand; too little and decision-making becomes impossible.

Wayfinding for cycling is similar to guide signing for drivers, information provided to users who are moving must be provided in advance of where major changes in direction are required, repeated as necessary and confirmed when the manoeuvre is complete.



6 Help users learn

For many in the target market for cycling, the process of travelling by bike will be new or largely forgotten. Wayfinding information should take this into consideration and seek to help newcomers to cycling understand what is accessible and how to navigate the network and challenging situations.

Wayfinding information provided for bike facilities should also complement other information such as maps and on-line resources so that learning is easier and quicker.



7 Keep information simple

Information should be structured and presented to the rider in as clear and logical form as possible. During a journey, a cyclist may have to make decisions quickly for safe movement. Too much information requires extra time to understand and use.

Badly designed, structured or located information forces users to spend more time wayfinding. The longer someone has to try to understand information, the less likely it will be used.

1.4 Destinations

Principle 1 Connect Places

Encourage new cyclists to undertake journeys by bike instead of less sustainable modes. (See page 8 for principles.)

Destination hierarchy

Following from the first principle, "Connect Places", the major focus of these Guidelines is how to guide cyclists along the designated cycling network to the places they want to go. In order to do this, a set of destinations and their names must be agreed regionally. It is extremely important that any wayfinding system refers to destinations consistently and predictably until they are reached.

A hierarchy of destinations is necessary in order to prioritize which destinations to include when there are too many possible destinations than can fit legibly on a sign. In preparing these guidelines, municipalities have agreed to the following hierarchy.

Level 1 – Urban Centres

These are the major centres of activity described in the Metro Vancouver Regional Growth Plan. The Urban Centres are the main centres within individual municipalities offering a full range of attractions and services, and provide the primary geographic orientation points for regional cycling.

Level 1 destinations are included on signs up to 8 kilometres away, the distance targeted for increased cycling mode share in TransLink's Regional Cycling Strategy. The map on the following page shows the Level 1 destinations and an 8 kilometre scale bar for reference.

Level 2 – Local Neighbourhoods

These represent centres of community with sub-regional importance. Local Neighbourhoods provide a mixture of services used by local people. The Level 2 destinations identified in these guidelines were selected by municipalities based on their suitability as wayfinding reference points, including being well-known, unambiguous, and having an identified core or heart.

Level 2 destinations are included on signs up to 4 kilometres away.

Level 3 – Major Attractions

These trip attractors include transit stations and exchanges, major tourist venues, regional parks, post-secondary education institutions and the region's border crossings.

Level 3 destinations are included on signs up to 2 kilometres away.

A full list of all the agreed destinations to be used on bicycle wayfinding is given at Appendix 1.

Level 4 – Local Destinations

A municipality may wish to extend the wayfinding system to include local destinations. This may be useful to reflect the nature of lower density areas or to integrate bicycle wayfinding with walking wayfinding on shared paths. They may also be useful if a municipality wishes to provide wayfinding signage on a route that does not connect Level 1–3 destinations.

It is however important to consider the principles and in particular, the need to keep information simple and consistent. Overloading signs with information often has the unintended effect of making them harder to understand and use.

It is not practical to list all the possible local destinations across the region, but the following represents some classifications that may be useful:

- **Recreational cycle paths**
- **Shopping centres**
- **Business parks**
- **Parks, open spaces and sports facilities**
- **High schools**
- **Landmarks**
- **Healthcare facilities**
- **Public washrooms**
- **Bicycle repair shops**
- **Civic facilities – community centres, libraries**

Level 4 destinations are included on signs up to 2 kilometres away.

Principle 2 Use Consistent Names

Use common terminology to allow cyclists to follow wayfinding signage across different jurisdictions. (See page 8 for principles.)

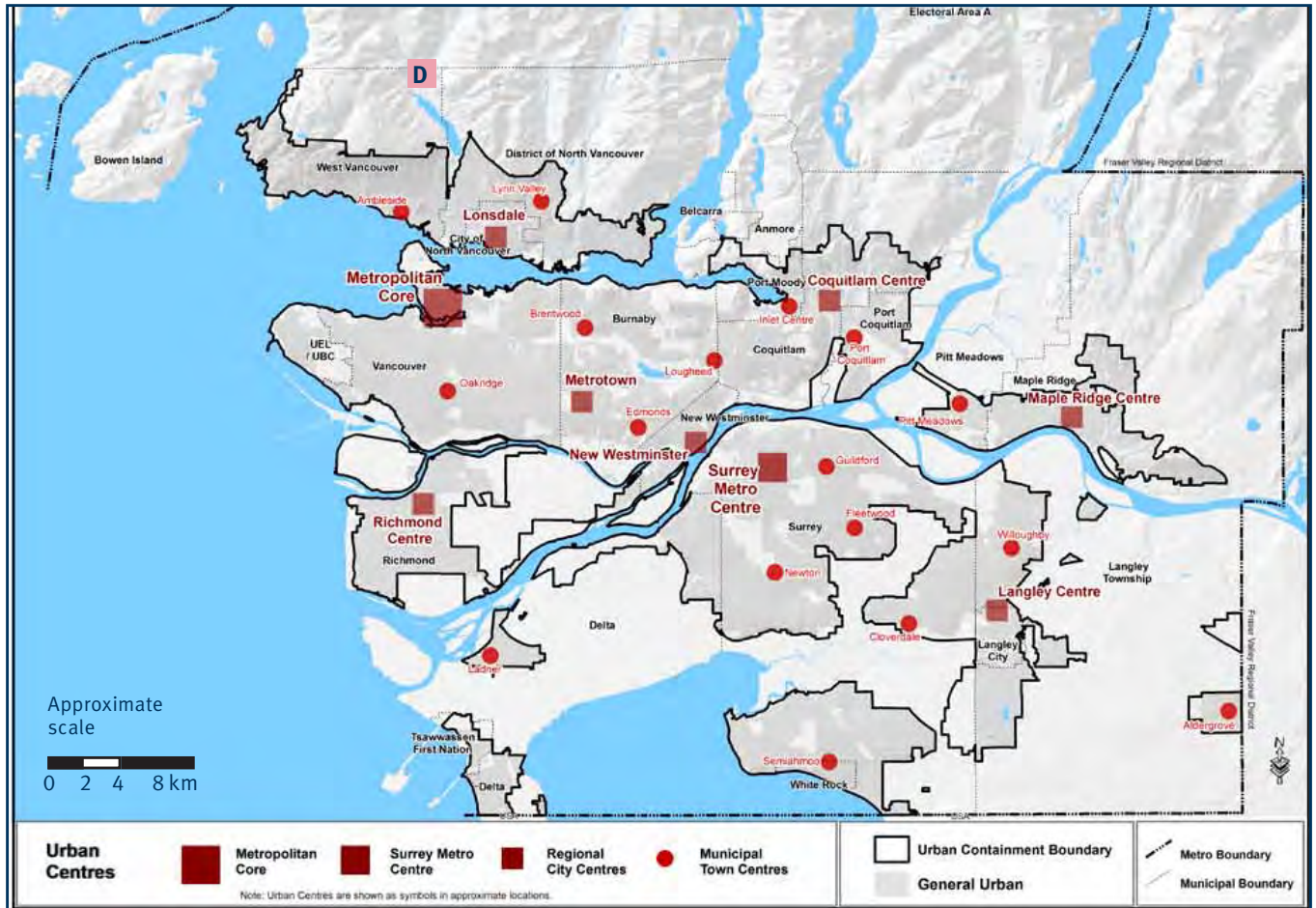

Level 1 – Urban Centres, from the Regional Growth Strategy



2.0 Regional Wayfinding System

Signs form the basis of the wayfinding system. This section describes the sign family, options for addressing complex situations and how to reduce excessive signage.

2.1 Sign family	14
2.1.1 What signs are needed?.....	14
2.2 Decision sign	16
2.2.1 Decision sign variants.....	17
2.3 Confirmation sign	18
2.3.1 Confirmation sign variants.....	19
2.4 Turn Fingerboard	20
2.4.1 Turn Fingerboard variants.....	21
2.5 Off-network Waymarker	22
2.5.1 Off-network Waymarker variants.....	23
2.6 Alternatives and enhancements to signs	24

Principle 5 Disclose information progressively
 Progressive disclosure spreads information along journeys in a logical way to avoid overloading signs and confusing users. (See page 9 for Principles.)

2.1 Sign family

2.1.1 What signs are needed?

Signage is necessary at intersections in the network to guide cyclists to their destination.

In most situations two signs are recommended in each direction at an intersection. These comprise a decision sign before the turn and a confirmation sign after the turn.

In some situations it may also be useful to add turn fingerboards to provide clarity at complex intersections, or waymarkers to highlight routes.

Normal situations

The default approach is to use two signs for each arm of an intersection.

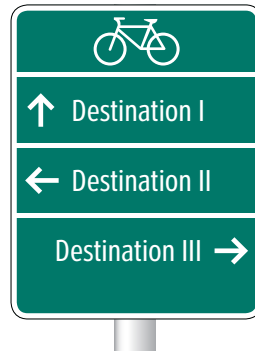

D Decision sign

On the approach to a decision point, decision signs point the direction to control destinations.



C Confirmation sign

After decision points, confirmation signs reassure cyclists of their direction and confirm additional destinations reached along that route.

This is the typical configuration of signs at a decision point. Each direction has a decision sign on the approach and a confirmation sign on the exit.

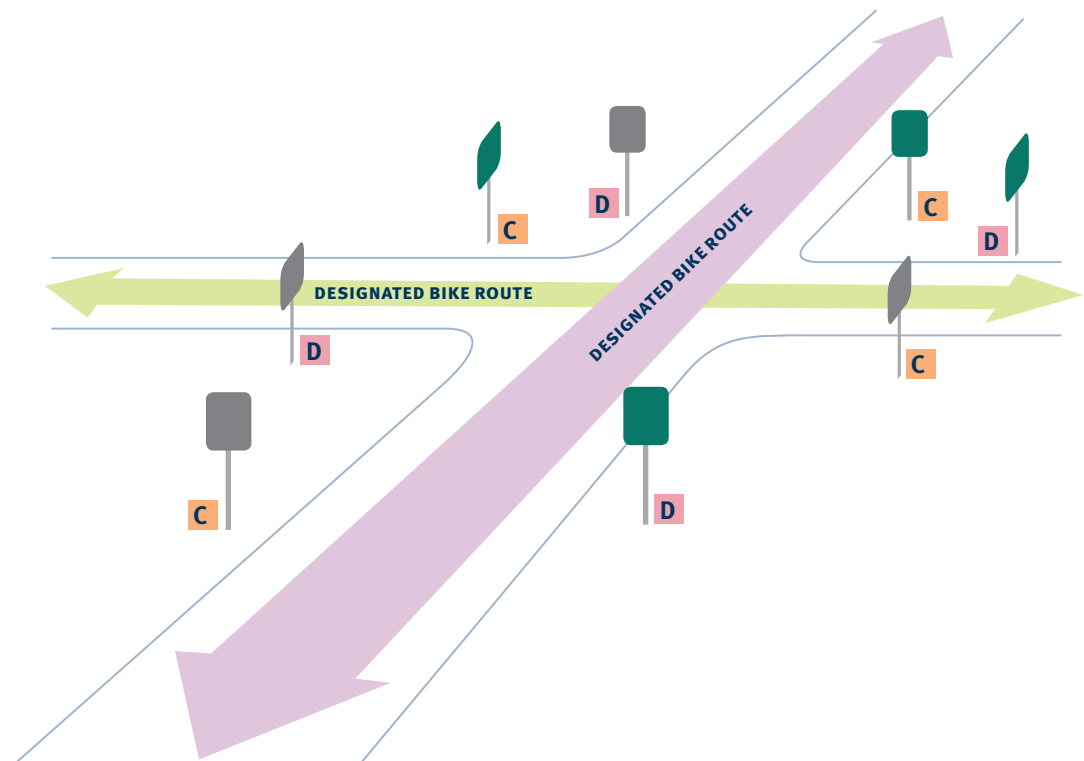

Special situations

In certain circumstances, where advance warning is required or where turns are concealed or unusual, these optional signs may be used in addition.



T Turn fingerboard

Optional fingerboard signs can be placed after the decision sign, at the point of the turn, to highlight unusual or easily missed turns.

W Off-network Waymarker

Waymarkers can be used on non-designated routes to guide cyclists to the designated cycling network.

R Bike route sign

Standard TAC signage* can be used as repeaters to confirm that cyclists are on a designated route where full confirmation signs are not practical. At route jogs, an arrow tab can be added.

Atypical situations where extra signage is needed to clarify complex intersections may benefit from the use of fingerboards, off-network waymarkers or bike route signs.

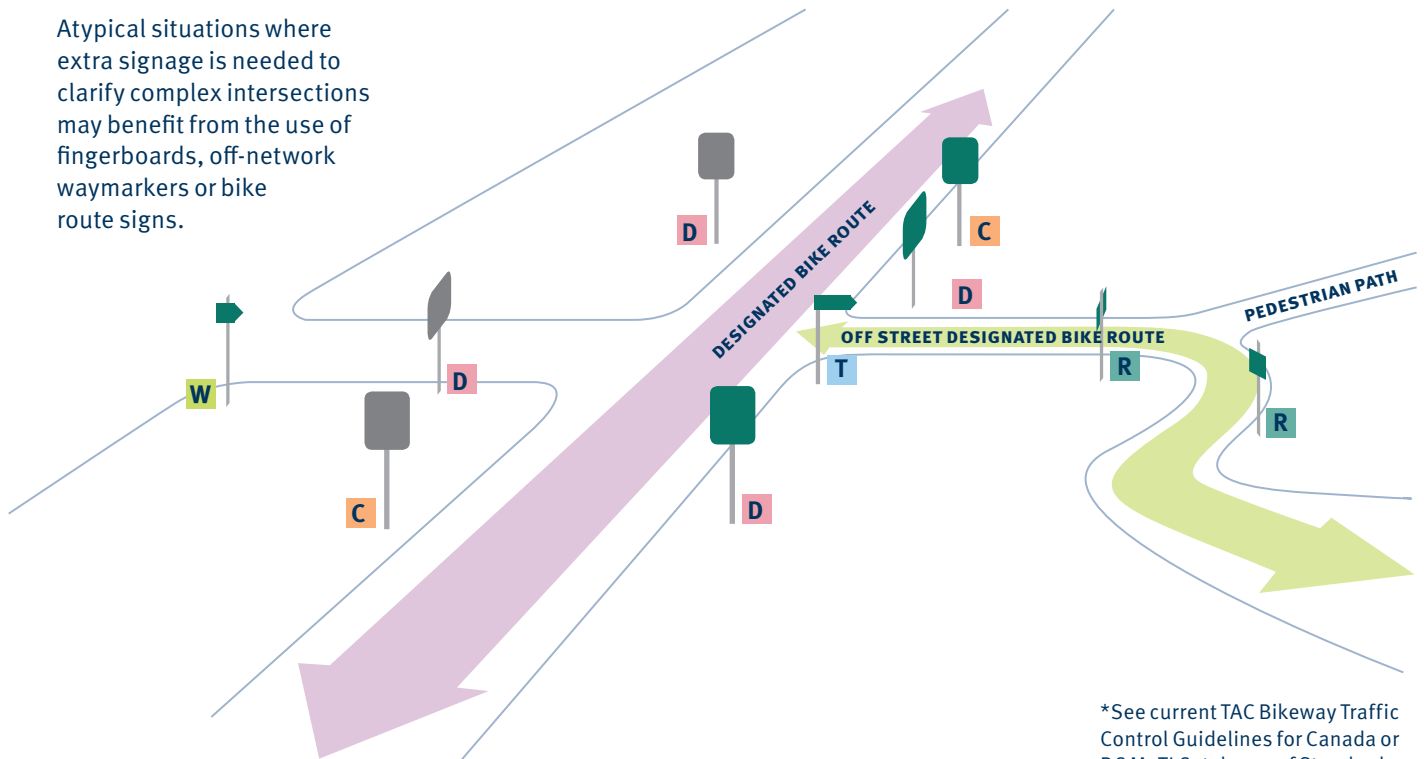

*See current TAC Bikeway Traffic Control Guidelines for Canada or BC MoTI Catalogue of Standard Traffic Signs.

Principle 5 Disclose information progressively

Progressive disclosure spreads information along journeys in a logical way to avoid overloading signs and confusing users. (See page 9 for Principles.)

2.2 Decision Sign

D

Decision signs provide directions to selected destinations.

They are located in advance of intersections to provide cyclists the time to slow and manoeuvre if necessary.



Placement

Decision signs should be located at a safe stopping distance before the turn (refer to TAC Bikeway Traffic Control Guidelines for Canada for minimum stopping sight distances for bicycles).

It is also important that decision signs are located so that the turn it refers to is obvious. Care should be taken not to locate signs close to lanes, paths and other accesses that could be confused with the designated bike route.

On routes where speed is likely to be high, decision signs can be repeated ahead of the turn. Repeated decision signs should be spaced according to the design speed.

Format

To manage the information load, in normal circumstances decision signs will contain up to three destinations. Long names may extend over two, or exceptionally three lines, and where alternative routes exist, the addition of subtext lines may be used.

Decision signs may also be designed as diagrammatic (map type) signs. These can be useful by illustrating circuitous routes or special features, such as crossings, without the need for complex text or multiple signs.

Content

Sign content is determined according to a system of progressive disclosure described in section 3.1.

Each direction on the Decision Sign should show a single control destination, which is the next Level 1 Urban Centre in that direction. If there is no Level 1 destination in that direction, then the highest ranking destination within its signing distance, or the route terminus, is shown.

Where there is a choice of route to reach a destination or a significant constraint on route choice such as a bridge, a subtext line indicating the 'via' route may be used.

To identify their function as bicycle wayfinding signage, the top portion of decision signs should include a bicycle symbol and the route name, if any. Destination content only appears on the lower portion of the signs.

Principle 7 Keep information simple
 A cyclist may have to make decisions quickly for safe movement. Signs with too much information may be missed or ignored. (see page 9 for Principles.)

2.2.1 Decision Sign Examples

This section shows typical layouts and common variations to accommodate additional information. Section 3.4.1 Decision Signs provides specifications for these and other variations.

See page 42 for design specifications and further variations

Text types



D1 Typical sign

D1.1 Including bikeway on route of travel

When a route is named, this name can be shown in the header section of the sign. When a route is also branded or coded this can be added as shown in D1.3.

D1.2 Included coded bikeway crossing route of travel

This variant shows how route coding can be incorporated if it is introduced in the future. Branding could also be shown in this way (see p41).

D1.3 Including code for route of travel

This variant shows how to indicate that the route on which the cyclist is riding is a coded route. Brand logos could also be included in the same way.



D1.4 Including descriptive subtext

The addition of a subtext indicating route characteristics such as via '(route name)', 'via (name) bridge', 'via scenic route' or 'via quiet route' can help cyclists make decisions about the journey ahead.

Map types

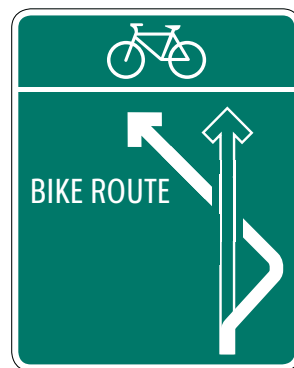

D2 Typical map type sign

Map type signs should be considered unique to the circumstances they depict. The sign shown is illustrative of one possible approach only.

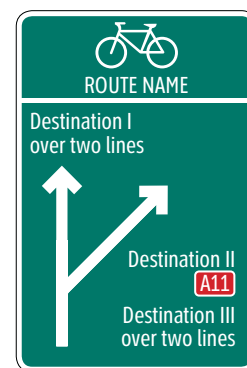

D2.1 Map type signs with named branded or coded routes

2.3 Confirmation Sign



Confirmation signs are used to reassure cyclists that they are on the correct course for their destination. They also provide information about other destinations that may be reached on the route.



Placement

Confirmation signs should be located at 20–30 m after turns. This proximity reinforces the correct exit route. This is especially relevant where a single bike route travels through a complex intersection.

Confirmation signs may also be used alternately with standard BC MoTI or TAC Bike Route signs to reassure cyclists on long sections of route. A suggested frequency for reassurance signs is every 400 m in urban areas and every 800 m in rural areas. Frequency should be increased where there are changes in route direction or where there are side routes that could be confusing.

A further way to reassure route choice is to ensure that street name signs are installed at every bike route intersection, including where off-street trails cross or join public roads.

Format

Confirmation signs are located after turns where information load is less distracting. For this reason it is possible to include destination names and distances. Normally three, and up to four, destinations would be shown in ascending order of distance. Where necessary, subtext lines may be included under destinations, though they should be limited to avoid overloading cyclists with information.

Content

Confirmation signs should always include the next Level 1 Urban Centre or the terminus of the route whichever would be reached first. Other destinations should be included according to rank and relative proximity.

Confirmation signs should always include distances to the nearest whole kilometre. When the distance is below 2 km, fractions of 0.1 km can also be used.

Further guidance on sign content design is described in section 3.4.2.

2.3.1 Confirmation Sign Examples

See page 52 for design specifications and further variations

This section shows typical layouts and common variations to accommodate additional information. Section 3.4.2 Confirmation Signs provides specifications for these and other variations.

Text type



C1 Typical sign



C1.1 Including bikeway name header

When a route is named, this name can be shown in the header section of the sign. When a route is also branded or coded this can be added as shown in C1.2.



C1.2 Including route code

This variant shows how to indicate that the route on which the cyclist is riding is a coded route. Brand logos could also be included in the same way. See p41.



C1.3 Including descriptive subtext

The addition of a subtext indicating route characteristics such as 'via (route name)', 'via (name) bridge', 'via scenic route' or 'via quiet route' can help cyclists make decisions about the journey ahead.

Multi Use Path types



C2 Shared path

Sign indicating shared route which may be used in place of confirmation sign C1 or C1.1 on shared paths.

If a route is named, the route name should replace 'SHARED PATH'.



C2.1 Shared path with horses

If a route is named, the route name should replace 'SHARED PATH'.



C2.2 Shared path with skaters

If a route is named, the route name should replace 'SHARED PATH'.

2.4 Turn Fingerboard



Turn fingerboards are optional signs used to highlight turns from one designated cycle route to another. The fingerboard is useful for complex turns as its shape has the advantage of being inherently directional.



Placement

Situations where finger boards should be considered include:

- **To emphasize a turn in busy, built up areas where there are many distractions**
- **To indicate unusual turn geometry such as acute angles and bike only lanes**
- **In situations where the bike route turns and other arms of the intersection are not designated cycle routes.**

Route signs should be located as close as possible to the turning point. Normally turn fingerboards are located on the approach side of the turn but may be located on the opposite side where this makes directional or positional sense. Further guidance on siting signs is given in section 3.3.2.

Format

Turn fingerboards are located at the point where a cyclist may need to concentrate and so should be as simple as possible. Normally only one destination is included, but in quieter areas, such as off-street paths, two destinations may be used.

Content

Turn fingerboards should show next Level 1 Urban Centre (or if none, then the highest ranking destination in that direction), or the terminus of the route whichever is closest.

Where a second destination is included, it should represent the next highest ranking destination and, if more than one, the closest.

These signs should always include distances to the nearest whole kilometer. When the distance is below 2 km, fractions of 0.1 km can also be used.

2.4.1 Turn Fingerboard Examples

See page 58 for design specifications and further variations

This section shows typical layouts and common variations to accommodate additional information. Section 3.4.2 Confirmation Signs provides specifications for these and other variations.



T1 Typical sign

T1.1 Fingerboard including coded bikeway crossing route of travel

This variant shows how to indicate that the route on which the cyclist is riding is a coded route. Brand logos could also be included in the same way. See p41.

T1.2 Including descriptive subtext

The addition of a subtext indicating route characteristics such as 'via (route name)', 'via (name) bridge', 'via scenic route' or 'via quiet route' can help cyclists make decisions about the journey ahead.

Standard TAC signage to bicycle parking areas

Standard TAC signage can be used to provide turn information from designated bikeways to bicycle parking areas that are out of sight.



Principle 6 Help Users Learn

Help new or returning cyclists learn how to navigate the designated cycling network for regular or new journeys. (See page 9 for Principles.)

2.5 Off-network Waymarker



Off-network waymarkers are optional signs with the specific purpose of indicating short links to designated bike routes from other streets or paths.

To avoid confusing the meaning of the sign across the network, they should not be used for marking the route of designated bikeways.



Placement

Off-network waymarkers should be located immediately in advance of turns that lead directly to a designated bikeway, to reassure where there are jogs in links to designated bikeways. They may also be used as repeater signs on links but the intention is that they mark short, direct links to avoid a proliferation of signs.

As the signs are small, it may be appropriate to locate them at eye height on walls, on low posts or in combination with other street signs to reduce clutter, provided they remain clear and logical in the context of the link direction.

Further guidance on siting signs is given in section 3.3.2.

Format

These signs are small fingerboards and the content is purposefully as simple as possible to act as a 'breadcrumb trail' to the designated bikeway.

Content

Off-network waymarkers do not contain destination information but may include a route name or brand logo. It is critical that all Off-network waymarkers include the word 'To' to confirm that they are not signing the route of a designated bikeway but access to it.

2.5.1 Off-network Waymarker Examples

See page 66 for design specifications



W1 Typical sign

Used on non-designated cycle route to direct cyclists to a designated route.

Waymarkers direct either ahead, left or right.

The 'straight ahead' version can be used as a repeated sign to instruct cyclists to continue in the direction they are going.

2.6 Alternatives and enhancements to signs

Optimizing signage

These guidelines provide designs that encourage consistency and continuity across the designated cycling network. However, it is important to strike a balance between a desire to provide information and the visual impact and maintenance burden of additional signage.

There are many ways to optimize signage so that it provides the information required but with the least possible amount of infrastructure. Simple ways this can be achieved include combining signs onto an existing pole or by replacing redundant or duplicate information with a single more comprehensive or better located sign. This can be especially useful when considering repeat signs which can create clutter if used excessively.

In some instances it may also be possible to enhance meaning, or to replace the need for a sign entirely, by using other forms of wayfinding. Common examples include pavement markings such as arrows, sharrows or medallions which have the benefit of being in the natural line of sight of a cyclist. While these are of limited value in destination wayfinding, they can support decision points and could be an alternative to repeat signs.

Note that pavement markings have limited usability when obscured by snow or leaves, and should be considered only as a component of a complete wayfinding system.



Legibility treatments

Signage provides cyclists with clear information about what route to take to reach their desired destination. However, in locations where the cycle route is complex or easily confused with the general street network or pedestrian-only paths, other visual cues can subtly guide cyclists. Such treatments can increase the legibility of the cycling route and reduce the need for extra signs.

This section provides some examples of types of legibility treatments that can be considered for cycling routes. However, it is not intended to provide comprehensive guidance, and specific projects will benefit from the advice of landscape architects, urban designers, or other professionals.

Types of legibility treatments



Surface treatments

A single contrasting colour or material for a cycling route can help define it in contrast to the surrounding surface, or adjacent pedestrian paths or traffic lanes. Distinctive markings, lines or dots can be used for similar functions. Surface treatments work especially well for cycling because of the natural line of sight while riding.

Furnishings

Some cycle routes, especially off-street paths, are furnished with items such as bollards, benches, lamp standards, and trash and recycling receptacles. Distinctive and consistent colours, materials and design reassure cyclists they are on the correct path.

Lighting

As with other furnishings, marking a route with a recognizable style of light standards can aid legibility. Moreover, the light itself can also support this function. A consistent level and quality of illumination along the route helps demarcate it from surrounding areas, with the added benefit that good lighting can improve safety.

Plantings

The use of distinctive plantings along a route can help define the line of travel. It is also useful when applied consistently at trail entry points, at either side of a road crossing, or other gateway or connection points. Plantings can also provide memories, through colour, scent and foliage that change seasonally and reinforce mental map development.

Public art

Public art can add to the identity, enjoyment, and legibility of a route. Large scale art can function as a beacon, especially useful for identifying a path entrance or continuation at a distance. Art with a consistent theme or style can also aid cyclists to distinguish the cycle route from the surroundings.

80mm



90°

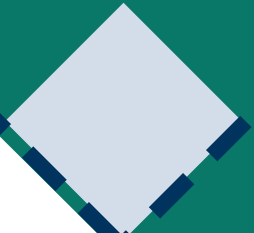

90°

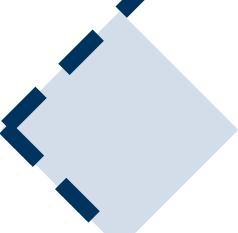

3.0 Design Guidance

This section describes how to assess, design and schedule a wayfinding project for a designated bicycle route or network. It gives examples of how to apply the design principles, how to approach atypical situations and provides specifications for the recommended signs.

- 3.1 Wayfinding strategy** 28
 - 3.1.1 System approach..... 28
- 3.2 Sign planning**..... 33
 - Planning exercise..... 33
- 3.3 Site assessment**..... 36
 - 3.3.1 General considerations..... 36
 - 3.3.2 Siting signs..... 37
 - 3.3.3 Route characteristics..... 38
 - 3.3.4 Atypical situations..... 38
 - 3.3.5 Maps and other wayfinding..... 38
- 3.4 Sign design**..... 39
 - General guidance..... 39
 - 3.4.1 Decision signs..... 42
 - 3.4.2 Confirmation signs..... 52
 - 3.4.3 Turn Fingerboards..... 58
 - 3.4.4 Off-network Waymarkers..... 66
 - 3.4.5 Pavement Markings..... 68
 - 3.4.6 Specifying for manufacture..... 69

Principle 1 Connect Places

Encourage new cyclists to undertake journeys by bike instead of less sustainable modes. (See page 8 for Principles.)

3.1 Wayfinding strategy

3.1.1 System approach

The Regional Bicycle Wayfinding Guidelines are intended to promote utility trips between the principle destinations in the region using the designated bike network.

The cornerstone of the approach has been to agree on a list of destinations ranked according to trip attractiveness. This destination hierarchy is included at Appendix 1 of the guidelines and represents all the destinations that should be included (see also section 1.4 above).

Each authority that proposes to implement bicycle wayfinding should design signs using these destinations and the same design steps in order to ensure consistency.

Given the multiple route possibilities between destinations in the network, it is advisable to develop a wayfinding plan for the entire network rather than on a route-by-route basis.

These steps are described in the following sections:

- A Consult on local destination hierarchy**
- B Define a network to be signed**
- C Divide the routes into segments**
- D Define links to the route segments**
- E Identify the decision points**
- F Prepare a sign schedule**

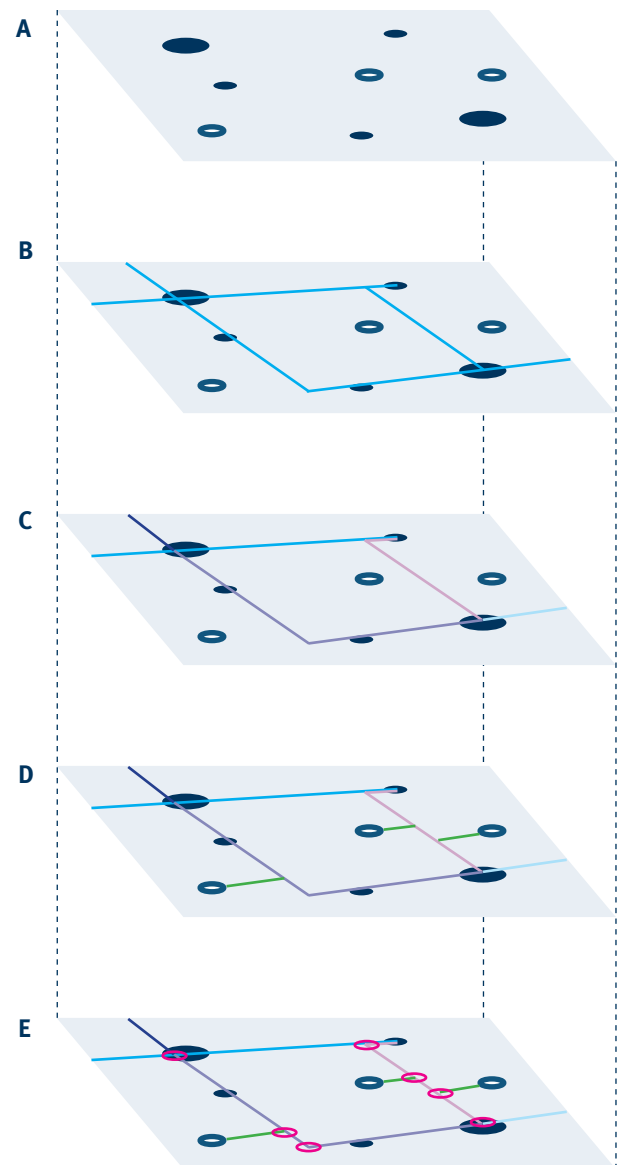

The wayfinding system is designed to connect agreed places using the bike network for utility cycling trips. To be consistent across the different areas of the region, a systematic approach is necessary.

A Local destination hierarchy

The agreed regional destinations are listed at Appendix 1. In general, regionally agreed destinations include Level 1 Urban Centres and Level 2 Local Neighbourhoods (identified through the Regional Growth Strategy and local Official Community Plans) as well as Level 3 Major Attractions. However provision is also made to extend this list further to include a Level 4 class of Local Destinations (see section 1.4 for advice).

Any authority wishing to include local destinations in their bicycle wayfinding should consider the likely need for additional signage to accommodate the extra destinations and the related need to maintain the accuracy of the information.

B Signed network

All the destinations selected in Step A should be connected by bike routes to be included in the regional wayfinding system. Routes between Level 1 Urban Centres and Level 2 Local Neighbourhoods will be the most heavily used for utility cycling and these should be identified as the primary network to be signed.

A planning exercise, preferably as part of a local bike route plan, should establish which designated bike routes are best suited to connect the Level 1 Urban Centres and Level 2 Local Neighbourhoods. Considerations should include who will use the signs and where they may wish to ride for utilitarian purposes. TransLink's document 'Cycling for Everyone: A Regional Cycling Strategy for Metro Vancouver', includes a Bikeway Facility Classification that describes the physical route characteristics which best support utility cycling. Further consideration should be given to route connectivity beyond municipal borders indicating the value of liaising with neighbours.

This exercise will provide a network of connecting routes to be signed. It should be noted that some designated routes may be omitted if they do not connect significant trip-generating destinations while other routes may be added if they run parallel or are recreational trails that offer cyclists quieter or more scenic options.

It is also conceivable that some destinations cannot be accessed from a designated bike route. In these cases the authority should decide whether to include minimal directional signage as an Off-network Link (see Step D below), or to defer signing until a suitable route has been identified and upgraded to meet minimum facility standards.

C Route segments

A developed cycling network may include long routes that join several intermediate destinations. Because of this, using the route's end points as control destinations on signage may not always be most useful to cyclists.

When preparing a schedule, it is useful to consider long routes as a series of smaller segments, with a Level 1 or Level 2 control destination at each end of the segment. These segments are purely planning tools, and not explicitly named or presented to the public.

Each segment should start and end at a destination to produce logical wayfinding signage. The wayfinding signage will join the segments into a series of steps for people on longer journeys.

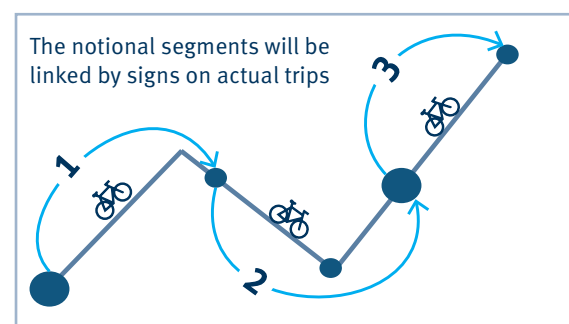

Principle 5 Disclose information progressively

Progressive disclosure spreads information along journeys in a logical way to avoid overloading signs and confusing users. (See page 9 for Principles.)

Advice for defining route segments:

- **Segments should only start and end at the Level 1 and 2 destinations to ensure that wayfinding directions benefit the widest number of users.**
- **Segments should not start or end at Level 3 Major Attractions or Level 4 Local Destinations but may connect them if they are on the route.**
- **The length of each segment should ideally not exceed 8 km. Where this is not practical segment lengths may be increased.**
- **In order of preference, segments should connect: Level 1 Urban Centres to other Urban Centres, Urban Centres to Level 2 Local Neighbourhoods and Level 2 Local Neighbourhoods to other Local Neighbourhoods.**
- **Where routes cross bridges, segments may end at the bridge if it is more logical that signs direct users to a municipality than a specific destination e.g. ‘North Vancouver via Second Narrows Bridge’.**
- **It is acceptable for parts of different segments to share a route between destinations e.g. the BC Parkway and Central Valley Greenway run along the same route into Downtown Vancouver from different points.**

D Links to segments

The route segments identified in the previous step link all the Level 1 and 2 destinations in the network, as well as any Level 3 and 4 destinations located along the way. There will likely also be some Level 3 and 4 destinations that are not on these segments, but still reachable via designated bike routes. Fewer cyclists are expected to use these routes, because they join destinations that are smaller trip generators. These designated routes are Links between the Level 3 or 4 destination and the segments that join greater trip generators.

Links may be signed in the same way as network segments. However, to optimize funding for greatest benefit, a municipality may choose to sign network Links as a secondary priority. In this case, a Turn Fingerboard can be included on the network Segment at the intersection with the Link, and the remainder of the Link identified merely

with TAC Bike Route signs (see page 17) and not destination signage.

After network Segments and Links have been identified, there may still be some Level 3 and 4 destinations that are not on the designated bicycle network. Generally, wayfinding signage should only occur on the designated bicycle network.

In rare cases where a municipality must guide cyclists to and from a Level 3 or 4 destination that is not yet on the designated bicycle network, an Off-network Link may be identified. Signing toward this destination warrants a Turn Fingerboard at the turnoff point, but no further signage en route to the destination, as cyclists should not be guided along routes that do not meet minimum standards.

For this reason, Off-network links should only be identified when the destination is relatively close to the designated network and reachable in a straight line. Signing from this destination would require Off-network Waymarkers toward the designated network.

E Decision points

The preceding steps produce a map with all the agreed destinations connected by a network of segmented routes and links. At each intersection of two or more designated bikeways, a decision point is created where cyclists must choose which designated route to follow to their destination. At these intersections, Decision Signs and Confirmation Signs should be considered.

Other types of decision points may merit different signing approaches. Where a designated route turns at an intersection, but there is no choice of an alternate designated route, standard TAC Bike route signage with an arrow tab (Sign Type R on page 17) may be sufficient.

There may also be points where a designated route intersects with the normal street network in a way that is confusing to follow. At these locations, Confirmation Signs or TAC Bike Route signage may be useful to guide and reassure cyclists.

Principle 5 Disclose information progressively

Progressive disclosure spreads information along journeys in a logical way to avoid overloading signs and confusing users. (See page 9 for Principles.)

F Sign schedule

The sign schedule is the last part of the planning process. The sign schedule is a list of all the directional signs needed along each route, their location and the directions to be included on signs. The sign schedule should cover the whole route including all its component segments.

Preparing the sign schedule requires a consistent logic to be applied to the directions. Once included on a sign it is most important that a destination is signed continuously until it is reached. This can be challenging however as signs have a limited text capacity and there may be many possible destinations that could be included.

Progressive disclosure

In keeping with Principle 5 'Disclose information progressively', information is spread along the journey. This manages the demand on cyclists' attention to just what is required at that point in the journey, and also decreases the amount of information on any individual sign and therefore avoids unnecessarily large signs.

Signing distances suggest the maximum distance that different destinations should appear on directional signage. This simple process ensures that directions to the most important places take priority on signs.

Signing distances

Type of destination	Normal max. signing distance
Level 1 Urban Centres	8 km
Level 2 Local Neighbourhoods	4 km
Level 3 Major Attractions	2 km
Level 4 Local Destinations	2 km

Notes on signing distances:

1. Exceptions to these normal maximums may include long sections of route without qualifying destinations. Here it is acceptable to indicate the next highest level destination.
2. Level 2 Local Neighbourhoods selected as segment ends may also be signed from up to 8 km away in low density areas.

3. Distances are measured either to the boundary or the heart of the destination, as appropriate. Level 1 Urban Centres are typically large areas, so distance should be measured to the nearest boundary the cyclist will reach. Level 2 Local Neighbourhoods should be measured to the heart or centroid of the neighbourhood, which is typically a more well-known reference than its boundaries. Level 2 centroids are included in Appendix 1. Level 3 and 4 destinations are typically specific addresses or small land parcels and should be measured directly to the destination. If a Level 3 or 4 destination is large (for example, some parks or recreational trails), distance should be measured to the point at which the cyclist would arrive at the destination given the current path of travel.
4. All distances should be measured along the traveled path from the intersection to the centroid or boundary to the nearest 0.1 km.

Connecting segments

The idea of using segments for planning is to ensure that directions generally refer to moderate distances. However some people will want to ride on longer journeys where segments form longer routes. To ensure the segments are signed continuously, where they form a route, it is important that the wayfinding signs continue through the segments ends. This is achieved using the two sign elements:

Decision signs – the highest priority destination in the straight ahead direction and within its signing distance should be shown until it is reached.

Once the cyclist is able to recognize the destination, the next successive Level 1 Urban Centre or Level 2 Local Neighbourhood may be shown as the straight-ahead direction on Decision Signs. The notes concerning exceptions to maximum distances should be applied if necessary to ensure a further destination is shown.

Once the cyclist has arrived at a control destination, the next Level 1 or 2 destination that anchors the end of the next network segment should appear on subsequent Decision Signs. The exact point at which it is appropriate to stop signing to the current straight-ahead destination

and change to the next one depends on what environmental cues are present to signal to the cyclist that they have arrived at the named destination.

Landmarks, neighbourhood name signs, store or street names, are some physical elements that can inform the cyclist that they have arrived at the destination, at which point it is logical to begin using the next straight-ahead destination on Decision Signs.

Confirmation signs – Confirmation signs show the straight-ahead destinations in order with the nearest destination at the top. The last destination typically matches the destination on the preceding Decision Sign. Intermediate destinations should be shown within the signing distance appropriate to their level.

Sometimes the number of possible intermediate destinations may exceed the number that can fit on a single Confirmation Sign. If so, priority should be given to the highest level destinations, as they are likely to be more popular destinations, and also better known, therefore making them more useful for geographic orientation.

Named routes

Route names provide a useful way to connect segments. The sign designs provide space for route names or brand logos to achieve this. A number of routes across the region are already named and advice on selecting new route names is provided in Appendix 2.

Atypical decision points

In some instances, wayfinding signs alone will not be adequate to guide riders through a complex decision point. Where these locations are identified in the planning stage, they should be highlighted for site assessment.

Preliminary directional content should still be included in schedules but notes should be included that will allow consideration of special wayfinding, such as diagrammatic signs or legibility treatments that can only be properly evaluated on site.

A sample sign schedule is provided on the following pages.

3.2 Sign planning

Planning exercise

The illustration shows a theoretical cycle network connecting the fictitious City of Eastville. In the following pages an example sign schedule is explained for the three decision points marked X, Y and Z.

Step A Consult on local destination hierarchy

The City of Eastville is planning its bicycle wayfinding. Eastville planners consult these guidelines to identify the relevant control destinations that have been agreed for the region. Eastville is a Level 1 Urban Centre while Midhurst and Westham are nearby Level 2 Local Neighbourhoods.

The River Path Trail, which runs through the City, is recognized as a Level 3 Major Attraction. Eastville Sports Complex is also identified by the City as a Level 4 Local Destination.

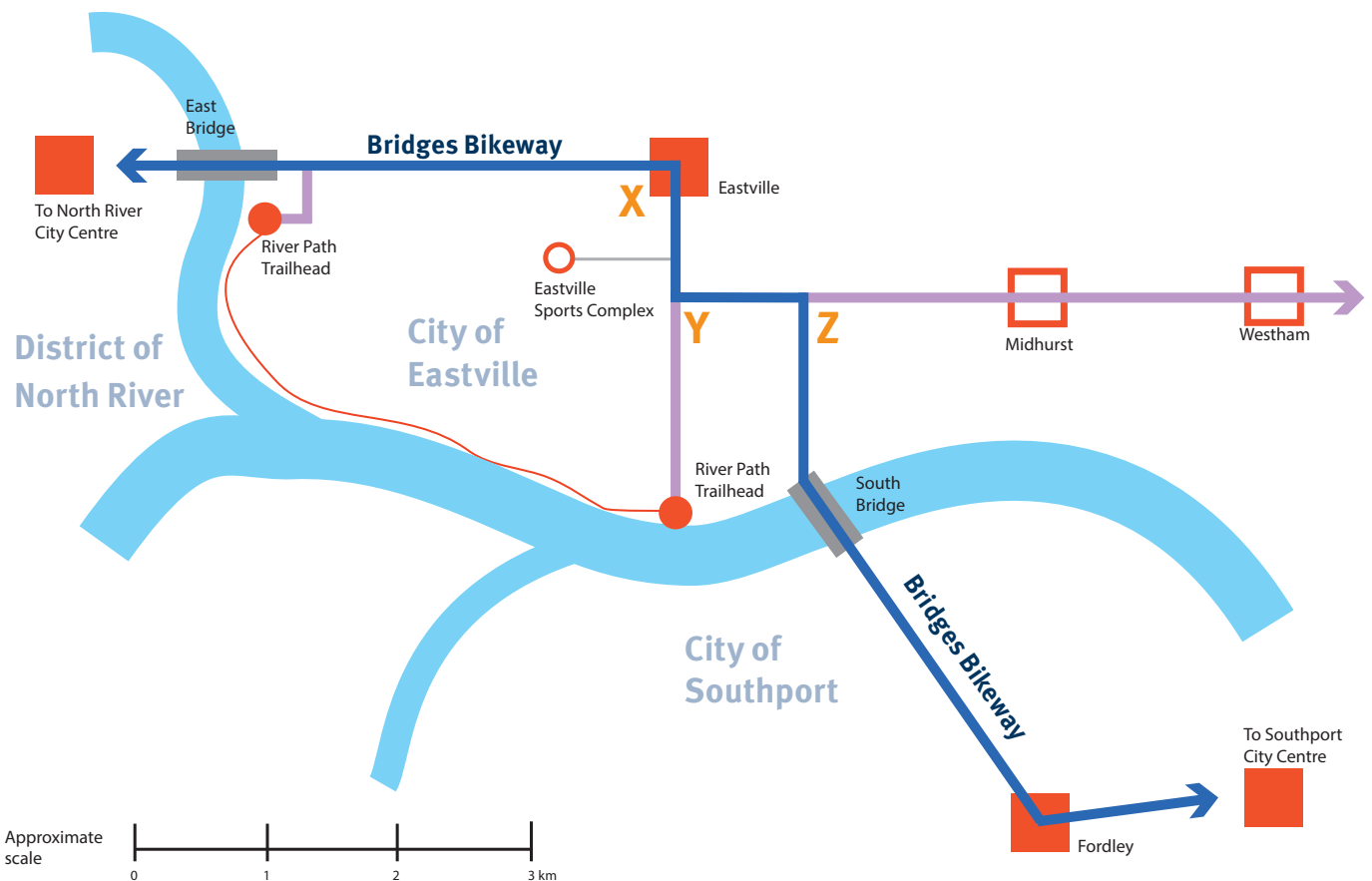

Key

- Level 1 – Urban Centre
- Level 2 – Local Neighbourhood
- Level 3 – Major Attraction
- Level 4 – Local Destination
- ▬ Bridges Bikeway route
- ▬ Unnamed designated bicycle route

Step B Define a network to be signed

The designated cycling network connects the City of Eastville to the neighbouring District of North River and the City of Southport via bridges.

The route between the bridges through Eastville is part of a long-distance regional route called the Bridges Bikeway. Unnamed designated bicycle routes connect Westham and Midhurst to Eastville via the Bridges Bikeway and the River Path Trail.

Step C Divide the routes into segments

For signage purposes the network must be divided into notional segments with anchor destinations.

Segment 1 connects Eastville to a bridge that leads to the District of North River. No Level 1 or Level 2 destinations are within the signing distance in North River so it is determined to be more logical to sign to the municipality.

Segment 2 connects Eastville to the Level 1 Urban Centre Fordley via South Bridge. Fordley is within the 8 km signing distance and will be signed.

Segment 3 connects Eastville to Westham which is a Level 2 Local Neighbourhood 6 km away. In this instance it is decided that while Westham is outside of its signing distance, the low density of the area makes it a logical segment anchor.

Step D Define links to the route segments

A designated route connects each trailhead of the River Path Trail (a Level 3 Major Attraction) to the Bridges Bikeway. These routes are identified as designated route Links.

The Eastville Sports Complex is a Level 4 Local Destination, but is not yet served by a designated bike route. However, there is a short, straight and quiet route connecting it with the Bridges Bikeway that Eastville plans to upgrade to minimum bikeway facility standards in the near future. In the meantime, this connection is identified as an undesignated route Link.

Step E Identify the decision points

For the purposes of the example, three decision points are selected. These are:

Point X – at the intersection at Eastville. All three segments connect here giving three destination choices at this point. Segment 2 and 3 run parallel to the south requiring a decision on the southbound direction. In this case, Fordley ranks higher than Westham.

Point Y – a right angle turn on the parallel route of segment 2 and 3 and an intersection with the link to the River Path Trailhead.

Point Z – the point where segment 2 and 3 divide before continuing to their respective destinations.

Wayfinding planning diagram

Key

- Level 1 – Urban Centre
- Level 2 – Local Neighbourhood
- Level 3 – Major Attraction
- Level 4 – Local Destination
- Planning Segment
- Link (designated bicycle route)
- Link (undesignated route)

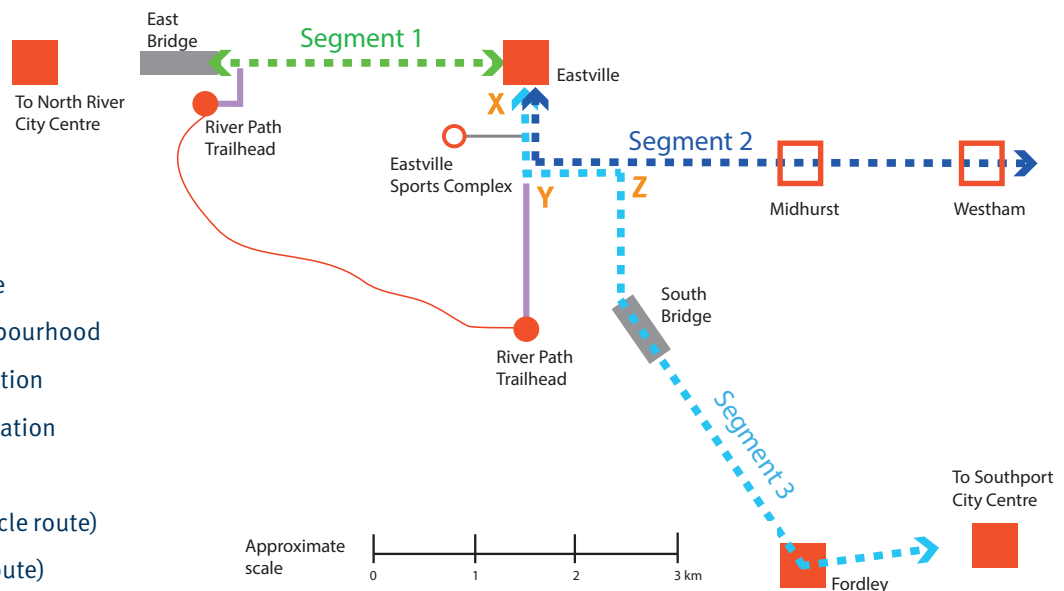

Step F Prepare a sign schedule

Each line of the following schedule represents a separate sign. In addition to the directional signs, repeat confirmation signs or BC MoTI or TAC Bike Route signs may be required.

Ref	Position	Sign type	Route name (for sign headers)	Content (italics denote subtext lines)	Notes
X	Nearside eastbound	Decision	Bridges Bikeway	→ Fordley <i>via South Bridge 6.5 km</i>	Fordley is a Level 1 Urban Centre and ranks above Westham which is the other segment end.
	Farside southbound	Confirmation	Bridges Bikeway	Eastville Sports Complex 1.1 km Midhurst 3.4 km Fordley <i>via South Bridge 6.5 km</i>	
	Nearside Northbound	Decision	Bridges Bikeway	← North River <i>via East Bridge 3.6 km</i>	The distance is measured to the municipal boundary. The trailhead is beyond its 2km signing distance
	Farside westbound	Confirmation	Bridges Bikeway	North River <i>via East Bridge 3.6 km</i>	It is not logical to include the trail access at this point in the journey
Y	Nearside southbound	Decision	Bridges Bikeway	↑ River Path Trail 1.7 km ← Fordley <i>via South Bridge 5.5 km</i>	Midhurst could be included within the maximum 3 destinations but is only shown on confirmation signs as it not a segment end
	Farside southbound	Confirmation	N/a	River Path Trail 1.7 km	
	Farside eastbound	Confirmation	N/a	Fordley <i>via South Bridge 5.5 km</i> Midhurst 2.4 km	Westham remains beyond its signing distance of 4 km
	Nearside westbound	Decision	Bridges Bikeway	← River Path trail 1.7 km → Eastville 1.1 km	
	Farside northbound	Confirmation	Bridges Bikeway	Eastville 1.1 km Eastville Sports Complex 0.9 km North River <i>via East Bridge 4.7 km</i>	
	Nearside northbound	Decision	N/a	↑ Eastville 1.1 km → Fordley <i>via South Bridge 5.5 km</i>	Route from the Dyke Trail – note this may be considered as a 'quiet route' alternative
Z	Nearside eastbound	Decision	Bridges Bikeway	↑ Westham 3.7 km → Fordley <i>via South Bridge 4.5 km</i>	At this point Westham appears as the eastwards segment end. Midhurst is an intermediate included on confirmation signs
	Farside eastbound	Confirmation	N/a	Midhurst 1.4 km Westham 3.7 km	
	Farside southbound	Confirmation	Bridges Bikeway	Fordley <i>via South Bridge 4.5 km</i>	
	Nearside northbound	Decision	Bridges Bikeway	← Eastville 2.1 km → Westham 3.7 km	
	Nearside westbound	Decision	Bridges Bikeway	↑ Eastville 2.1 km ← Fordley <i>via South Bridge 4.5 km</i>	
	Farside westbound	Confirmation	Bridges Bikeway	Eastville 2.1 km	

3.3 Site assessment

Introduction

The preceding section describes the planning process to determine a sign schedule suitable for site assessment. Site assessment is invaluable as it allows the designer to evaluate conditions, determine exact sign locations, and to identify any specific wayfinding challenges.

It is recommended that, where possible, site assessments are made by bicycle to give a representative perspective of the issues.

3.3.1 Geometric considerations

The site assessment is an opportunity to review geometric design considerations that relate to wayfinding including:

- **Should a bike box for a two-stage "hook" left turn be considered?**
- **Are sight lines acceptable?**
- **Are on-road to off-road transitions clear?**

For geometric design guidance please refer to:

The Transportation Association of Canada's Geometric Design Guide for Canadian Roads and Bikeway Traffic Control Guidelines for Canada provides guidance concerning the design of facilities.

National Association of City Transportation Officials (NACTO) Urban Bikeway Design Guide also includes additional information especially on Two stage Turn Queue boxes (Bike boxes for left turns).

Principle 4 Be predictable

If riders trust that they will encounter consistent and predictable information, new journeys can be made more easily. (See page 8 for principles.)

3.3.2 Siting signs

Placement recommendations based on TAC and MoTI guidance are provided below. However, engineering judgement and a review of the existing site conditions should also be used on a case-by-case basis to determine the specific placement of each sign.

Decision signs

Deciding the distance of a decision sign from a turn or transition will be affected by design speed, site lines and slope. Decision signs should be placed along the right-of-way in places where the cyclist can see an upcoming sign from an appropriate distance given the design speed and physical context. For guidance, see TAC Bikeway Traffic Control Guidelines for Canada for minimum stopping sight distances for cyclists.

Signs should be placed further from the intersection on busier streets with a centre turn lane or left turn pocket to decrease the possibility of conflicting cyclist/motorist movements while preparing for a left turn. The location of the sign should exceed the stopping distance needed by the fastest expected travel speed, but should not be placed so far in advance that the relevance of the sign is lost or forgotten.

Confirmation signs

Confirmation signs provide reassurance of direction after decision points, or repeated along long routes with no intervening destinations or decision points as follows:

- After a turn, the sign should be placed 20–30 metres following the intersection or decision point.
- Repeated signs in built-up areas, Confirmation signs should be placed about every two or three blocks, or 400 metres, to provide reassurance.
- Repeated signs in places where less reassurance is needed (for example, less built-up areas, low volume streets, or separated pathways) Confirmation signs should be placed roughly every 800 –1,000 metres.

Some other issues to consider include:

1 Turn fingerboards

Turn fingerboards have a supporting role and mark the turn. These are normally placed on the near-side of an intersection in close proximity to the turn. At large or complex intersections, it may be appropriate to place signs at both near and far sides or at multiple locations. In some cases, it may be appropriate to locate fingerboards only on the far side of the turn, including:

- T-intersections
- Off-street bike paths
- Two-stage turns
- Where a centre island or refuge is available

2 Place signs as beacons

In addition to the information they provide, bike route signs often provide the only indication of the presence of a bike facility. Confirmation signs should be used to mark the exit point of a bike route across a complex area.

3 Avoid suggesting unintended turns

When assessing sign locations it is important to take account of unintended turn options. A decision sign sited too far from the intersection may risk confusion if it appears to indicate a turn along a laneway, private access or pedestrian path.

4 Don't create obstacles

Signs are additional elements in the street and if poorly located, can restrict the available travelling space on a cycle route and so create a hazard for all users.

Illustrative sign placement for cyclist arriving at a T-intersection from the west

Sign type

- D** Decision sign
- C** Confirmation sign
- T** Turn sign (optional)

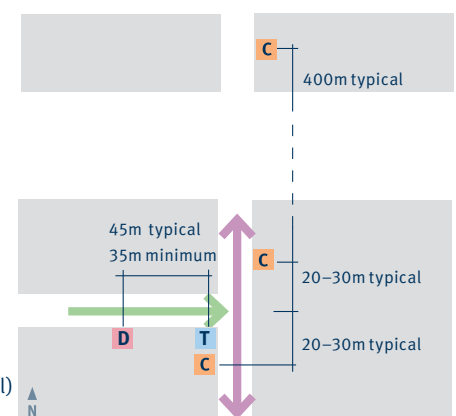

3.3.3 Route characteristics

A site assessment should always note changes in route character, surface condition or traffic speed and volume. Cyclists often select routes according to a range of factors including directness, suitability of the surface to the users bicycle, personal risk threshold and physical effort. Where route conditions change along its length a cyclist may look for alternative routes.

If possible, it is helpful to consider providing signage for alternative routes where:

- Paved routes become unpaved routes, or
- Quieter routes join much busier or faster moving traffic, or
- Routes climb steep hills.

3.3.4 Atypical situations

There are a number of situations that may be encountered during site assessment that go beyond a solution using the typical wayfinding signs recommended in the guidelines.

It is important to be able to recognize where a difficulty may arise for a cyclist. In some cases problems may be documented from users or advocacy groups, while in others, professional judgement should be used to assess existing locations or planned works.

Often the solution to problems such as accessing bridges, shared routes and multiple route choices may combine engineering and other forms of signage with wayfinding in order to fully help cyclists navigate safely and efficiently. In some cases legibility treatments may also be warranted.

Appendix 3 provides a range of examples of selected situations.

3.3.5 Maps and other wayfinding

Some locations may function as important nodes on the cycling network and be places where additional journey planning such as maps or route diagrams may be welcomed. Additional wayfinding at these nodes can help users navigate the transition between the utility cycling network, recreational cycling trails, and the public transit system.

Good candidates for such nodes include:

Transit facilities

The SkyTrain network, SeaBus and most off-street bus exchanges lie on or close to designated bike routes. Intermodal transport is an essential component of bicycle accessibility in many areas of the region.

Trailheads

In some areas, designated bike routes join trails and recreational paths. These provide access for recreational cycling and can be of regional or local importance as leisure or sporting attractions.

Principle 3 Maintain movement

Continuous, visible and clear wayfinding will help identify routes and enable cyclists to maintain an even pace (See page 8 for principles.)

3.4 Sign design

General guidance

Typeface

The typeface selected for the wayfinding sign designs is the Regular weight of ClearviewADA Condensed. This font has been selected as it meets US Americans with Disabilities Act (ADA) guidelines for legibility, and the Clearview family of fonts are increasingly being adopted for road signage in jurisdictions across North America.

ClearviewADA Condensed Regular is also a space-efficient typeface which is important to minimizing sign size and the resultant visual impact and use of materials.

The font is designed by Terminal Design and is available from their website www.terminaldesign.com

ABCDEFGHIJKLMN

abcdefghijklmno

1234567890

Typesize

For legibility at utility cycling travel speeds, these guidelines recommend typesizes of 50 mm cap height for destinations and 40 mm cap height for route names and subtext lines.

In sensitive or quiet off-street situations it may be appropriate to reduce typesize to 40 mm cap height for route names and directions and 35 mm cap height for subtext lines. This option could also be used if it provides better compatibility with branded signs.

50 mm cap height for destination names

40 mm cap height for subtexts and route name



The cap height of a typeface is measured as the distance from the baseline to the top of the capital letter.

Sign sizes

A consideration in the design of the system is optimizing sign sizes in order that they are manageable and affordable to produce but large enough to convey the information clearly.

All signs have standard sizes which will provide a sign large enough to show typical information.

Turn fingerboards and Off-network Waymarker sizes are demonstrated in the design specifications on the following pages.

Decision and Confirmation signs conform to the standards set out by TAC. Hence the standard width of Decision and Confirmation signs is fixed at 600 mm. Sign heights are however changeable subject to the required content.

The standard height of a Decision sign is 600 mm and a Confirmation sign is 750 mm. Both of these signs can be increased by an increment of 150 mm to 750 or 900 mm respectively if the necessary content does not fit within the standard size.

Where the designer believes the sign height needs to be increased further, the following steps should be followed until content fits within the sign:

- 1 Increase the standard sign height by 150 mm
- 2 Use standard abbreviations. These are listed within the relevant sections on the following pages
- 3 Remove a destination from the list adjusting upstream signs if necessary to ensure that once a destination is mentioned, it is shown consistently on Confirmation Signs until it is reached.
- 4 Reduce text size to 40 mm for destination names and 35 mm for subtexts (not advised for complex urban areas or where cyclists may be travelling faster than average, such as downhill)
- 5 If none of these options provide adequate space then consider taller signs using standard increments of 150 mm.

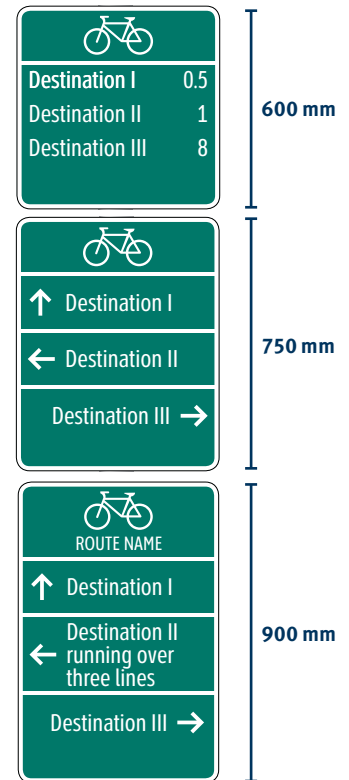

Decisions and Confirmation signs are designed to MUTCDC guidance, with heights increased in 150 mm increments

Branded and named routes

Allowance has been made in the designs to include elements that reference existing route names and brand identity.

Route names are indicated on wayfinding signs in header panels to enable integration with existing alternate systems of signage such as street name sign tabs.

Branded sign integration is more difficult to achieve as there is no standard branded sign. The option has been taken to allow brand logos to be included to recognize their special identity and to encourage adoption of the regional approach.



3.4.1 Decision signs

Standard dimensions

Panel size

600 x 750 mm

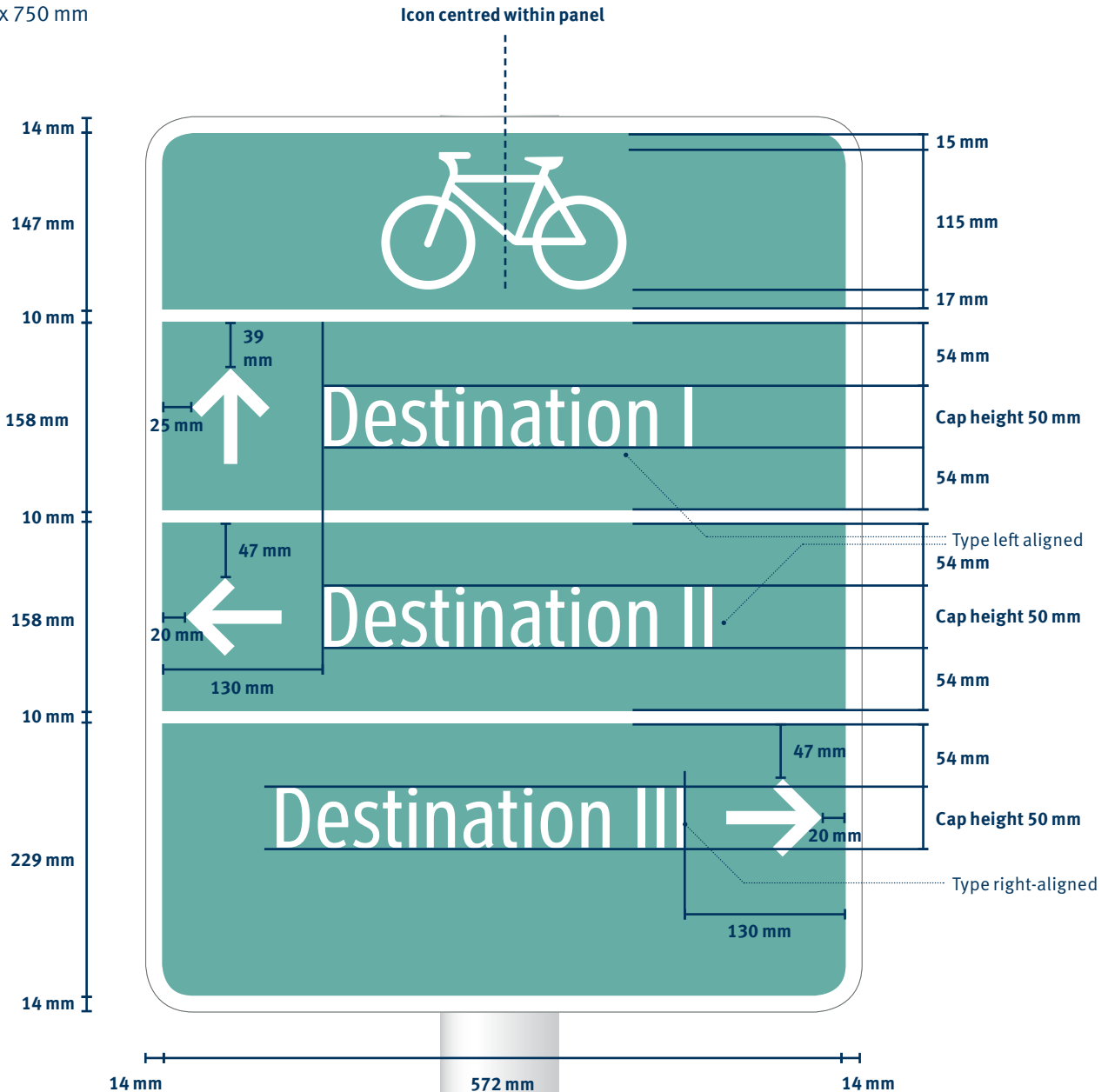

Sign colour

All signs should be standard white text on a highway green base. References for sign colours are available from the Transportation Association of Canada or BC Ministry of Highways and Infrastructure.

Decision signs should be designed in the way shown. Ahead directions should be shown first, followed by directions left and then directions right.



Standard elements

Bicycle icon



The bicycle icon should appear as shown. This icon should be consistent with TAC Bikeway Traffic Control Guidelines for Canada.

Directional arrow

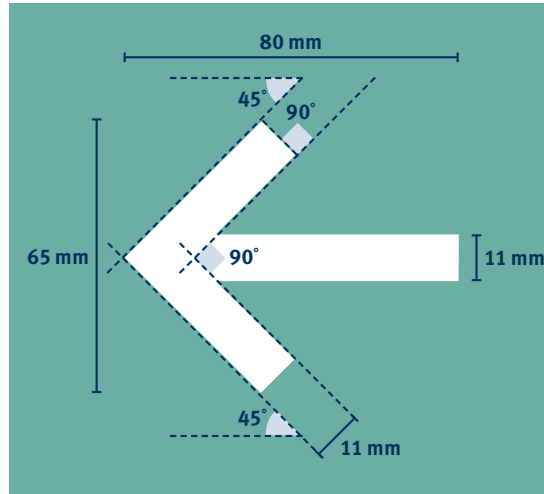

Arrows should conform to the specification shown. These are used as standard highway arrows may be less easily recognized at the small sizes appropriate to bicycle signage.

They should only be used at the orientations illustrated below. These orientations are set at 90° increments.



Arrows should conform to ahead, left and right directions only. Where unusual angles are required a Turn fingerboard or diagrammatic Decision sign is preferable.

Using icons



The use of icons to aid quick comprehension of common facilities is advised. Currently the icons included in these guidelines are a rail or bus icon to indicate transit facilities. Further icons can also be considered if they are of sufficient legibility and common usage to be widely understood when shown on signage. Standard icons can be found in the design templates that accompany these guidelines.

Icons appear at the end of destination names. They should be used in addition to the identifier ('Station' or 'Exchange', or their abbreviated versions, 'Stn' or 'Exch') not as a replacement.



Standard TransLink icons should be used

Using route codes



When route codes are shown as part of directional information (see sign D1.2, p17) they should be shown as illustrated with the code appearing on a second line below the relevant destination name. See 'Destination names that run to two lines' on the following pages for guidance on spacing of surrounding elements when adding a second line. Code should be left or right-aligned according to alignment of text.

When shown as part of the header section of the sign (see sign D1.3, p17) route codes should appear with the same dimensions as shown, but in the configuration shown right.

Adding a route name

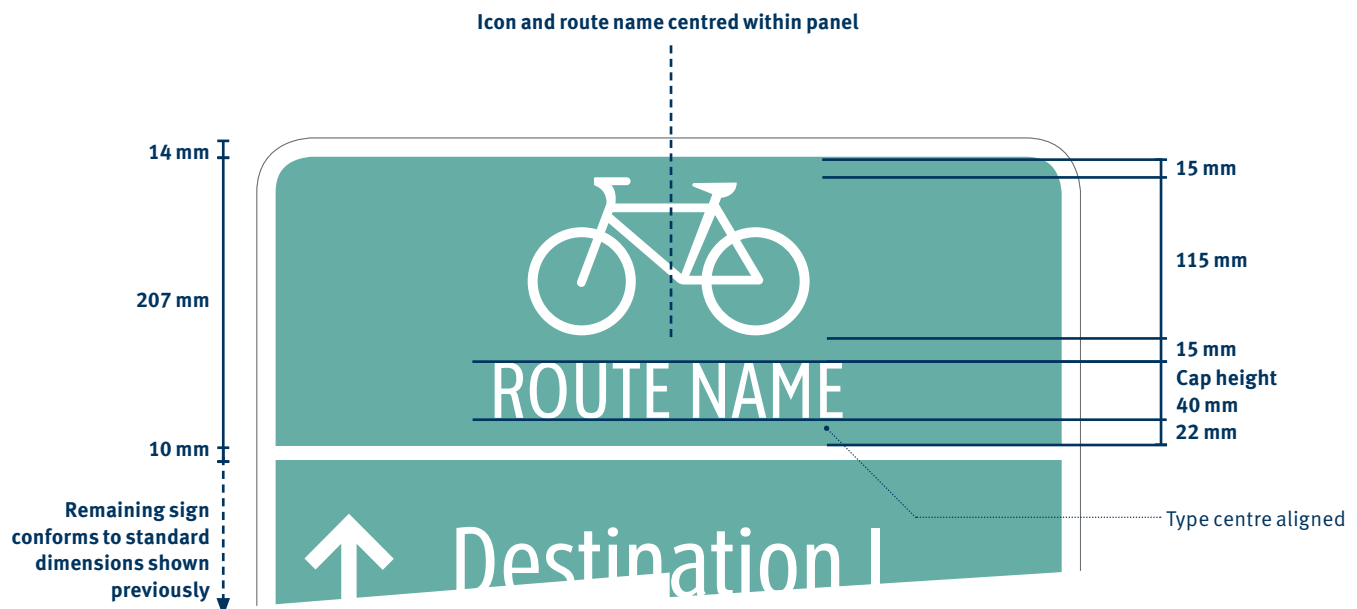



Adding a route code to the header section

When the cyclist is on a route that has a code reference and name, route codes can be introduced to the header section of the sign in the way shown. The code appearing to the left of the route name.

If the route has a code but not a name, the code should appear centred within the panel underneath the bicycle icon at the same height as shown.

When the cyclist is on a branded route, a brand logo can also be added to the sign in a similar way.

Route codes or brand logos will often be added to the sign as well as a route name, which should be incorporated as shown left.

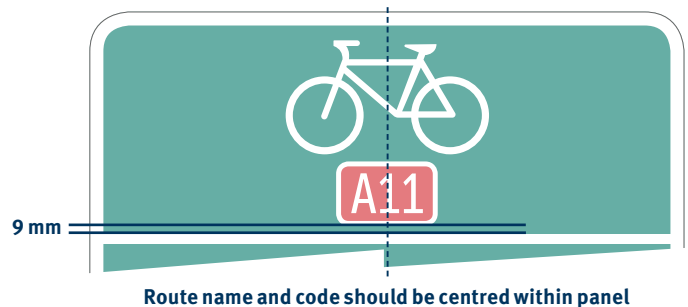
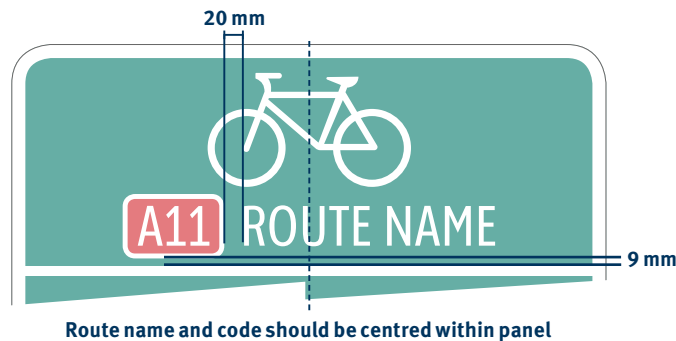

Route names that run to two lines

On some occasions a route name may be too long to fit within the width of the sign. In these cases the route name can run to a second line, as shown.

Where dimensions are not shown they are consistent with dimensions shown previously.

Creating space for this second line in the header will often mean that the sign will have to be increased in height from the standard size. See page 40 for more information on sign sizes.



Adding a subtext

Subtexts should be incorporated under the relevant destination name as shown. They should always be included on a second line, with a lowercase 'via'.

Note that the 158 mm containing area does not change regardless of the introduction of the new line.

When adding a subtext to a destination name that is already two lines, the designer should use the three-line specification shown on opposite.

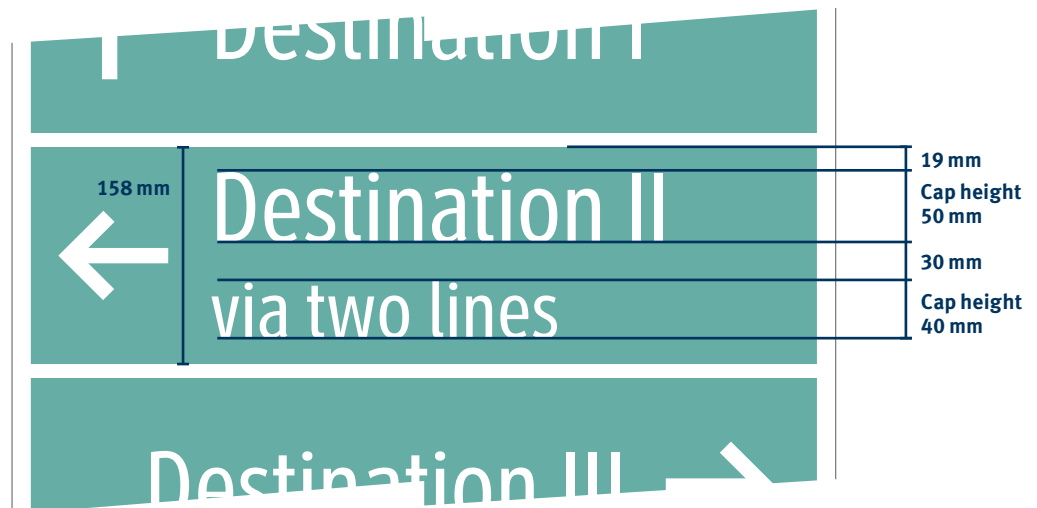

Destination names that run to two lines

Longer destination names may require two lines. This should be done as shown.

Again, the 158 mm containing area does not change regardless of the introduction of the new line.

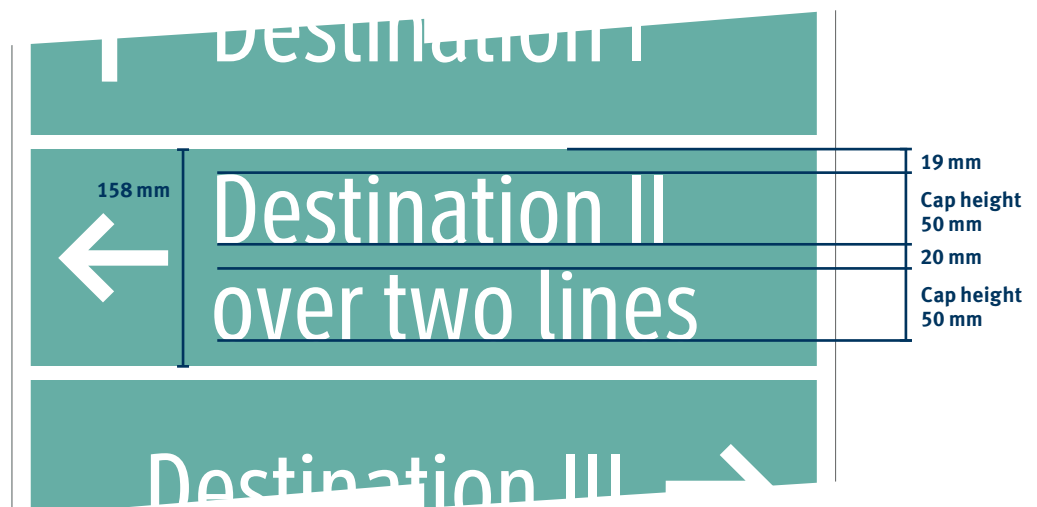



Destination names that run to three lines

On rare occasions it may be necessary to run a destination name over three lines.

Due to the reading time and space requirements, this is undesirable and should be avoided if possible by using standard abbreviations shown below.

Where essential displaying a destination name over three lines will require the sign to be extended to the next standard sign increment which is 900 mm. All other dimensions are retained.



When a destination runs to three lines the panel should be extended to 900 mm in height. See page 40 for more information on sign sizes.



Arrow vertically aligned within 228 mm space

Requiring 74 mm above and below an ahead arrow and 81.5 mm above and below a left or right facing arrow



Standard Abbreviations

Generally abbreviations should be kept to a minimum. However where necessary the following standard abbreviations can be used to avoid lengthy destination names.

Station = Stn

Exchange = Exch

Bridge = Br

North = N

South = S

East = E

West = W

More than one destination in a given direction

More than one destination in an ahead direction

When there is more than one destination in the ahead direction, the standard dimensions should be altered to appear like this.

Note that the dimensions of the left or right direction do not change, they only shift down to accommodate the greater height of the ahead direction.

Any dimensions not shown conform to the standard dimensions previously shown.



When all destinations are straight ahead, the layout shown should be used.



If a destination name requires a second line it should be implemented as shown previously with a 20 mm gap between lines. Subsequently all elements below are moved down to accommodate the new line(s). If more than one destination requires a second line the sign panel will have to be extended to 900 mm. All other dimensions stay the same.



More than one destination in a left or right direction

When there is more than one destination in a left or right direction, the standard dimensions should be altered to appear like this.

The dimensions of the ahead direction does not change.

Any dimensions not shown conform to the standard dimensions previously shown.

The examples shown illustrate destinations in the right direction. As would be assumed from previous sign illustrations, if creating a sign with destinations in the left direction, replicate the layout from the left edge of the sign instead of the right.

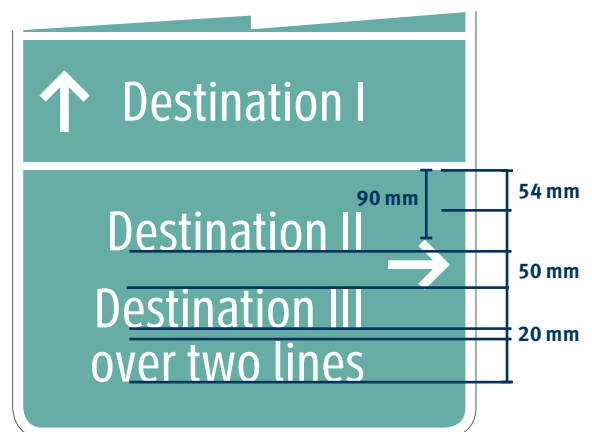
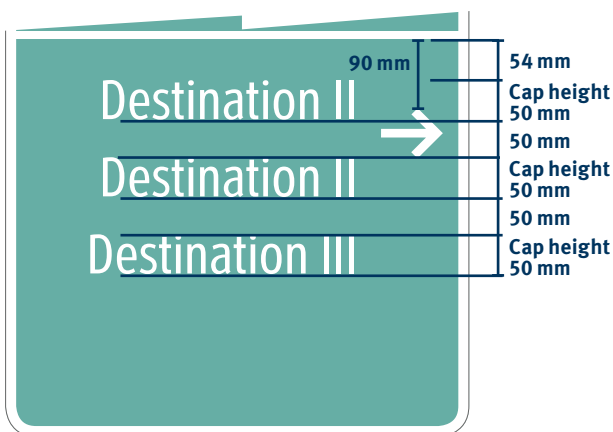
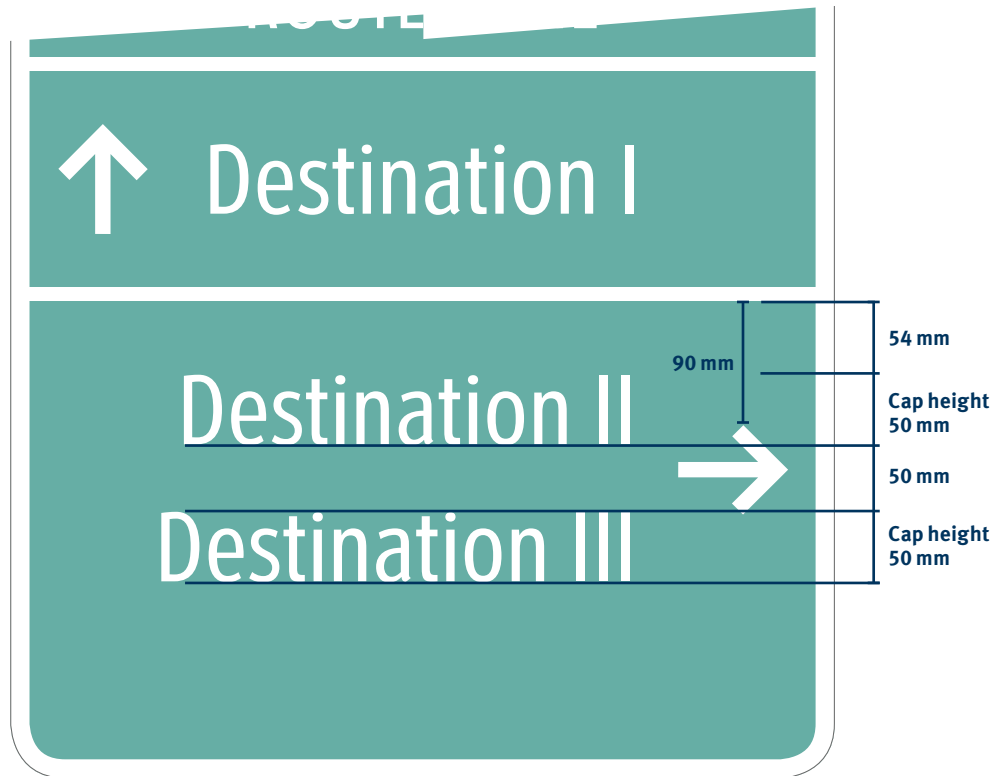

When all destinations are in a single direction turning from the route of travel the layout shown should be used.

If a destination name requires a second line it should be implemented as shown previously with a 20 mm gap between lines. Subsequently all elements below are moved down to accommodate the new line(s). If more than one destination requires a second line the sign panel will have to be extended to 900 mm. All other dimensions stay the same.

Map type signs

In situations where a standard decision sign does not provide enough detail at complex intersections, a diagrammatic sign may be used.

The number of permutations possible with these types of signs prevent guidance on all possible designs. Instead, basic guidelines are shown to inform design work.

The diagram should be centred within the available space with a margin of at least 20 mm

The diagram should be centred within the available space with a margin of at least 20 mm

Header sections of the sign follow the same specification as standard Advanced Directions signs

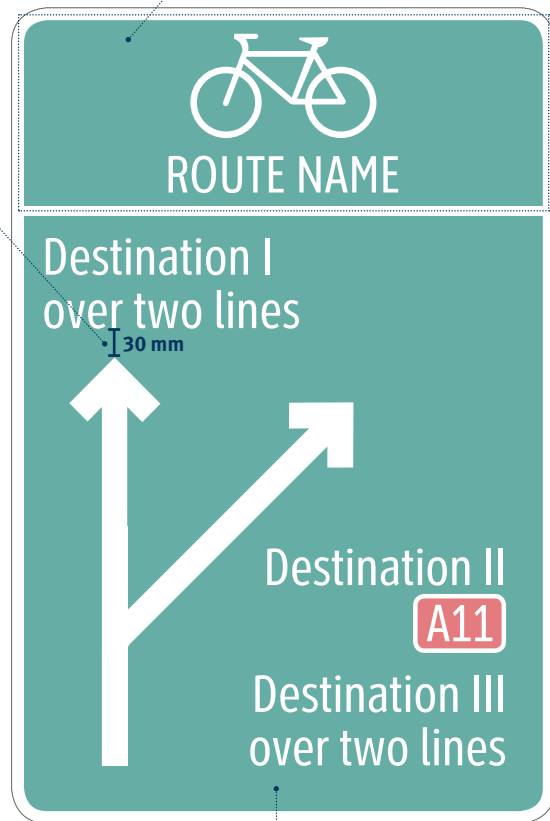

As much as possible regular shapes and angles should be used for linework (circular curves, 90°, 60°, 45°, 30° angles)

Type should have a cap height of 50 mm. If this is not possible due to space constraints, 40 mm cap height can be used

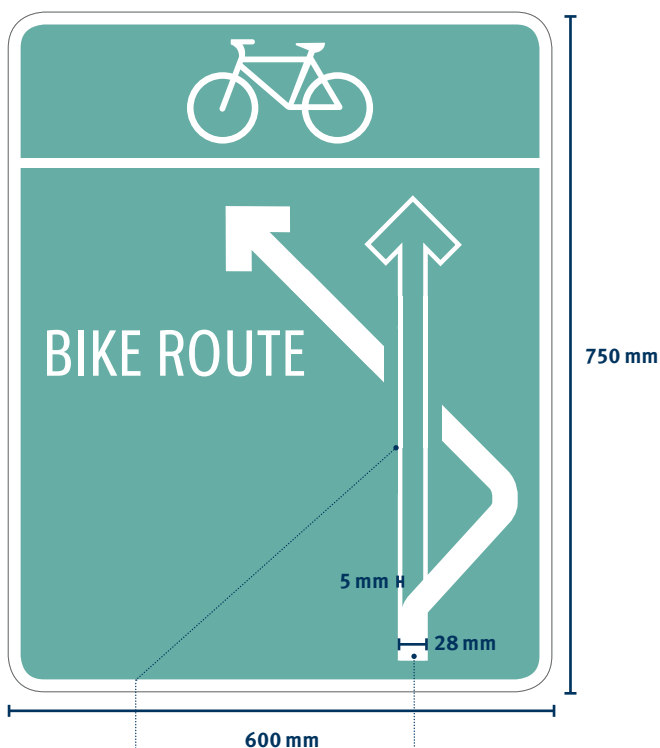

Outline linework is used to denote an undesignated cycle route or an alternative that is not advised

Linework should be 28 mm wide, apart from an optional outlined linework version which has a width of 5 mm

Diagrammatic sign design guidelines

- Diagrams should be as clear as possible and show a simplified view of the intersection ahead. These signs should not be used to show long sections of route.
- Signs should conform to the standard sizes (600 x 750 mm or 600 x 900 mm), dependent on size of the diagram.
- Header sections of the sign follow the same specification as standard Decision signs.
- Type should have a cap height of 50 mm. If this is not possible due to space constraints, a 40 mm cap height may be used.
- The diagram should be centred within the available space with a margin of at least 20 mm.
- Type should be placed with a 30 mm gap between it and any diagram line work.
- Linework should be 28 mm wide, apart from an optional outlined linework version which has a width of 5 mm.
- As far as possible regular shapes and angles should be used for linework (circular curves, 90°, 60°, 45°, 30° angles).
- Common elements such as border widths conform to Decision sign specifications previously stated with exception to the arrow, which is shown below.

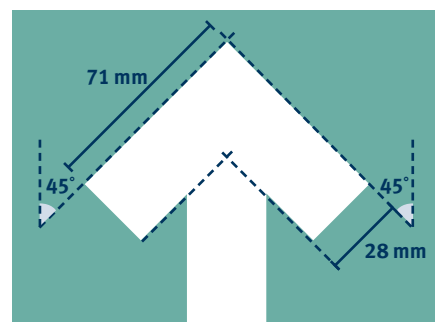

3.4.2 Confirmation signs

Standard dimensions

Panel size

600 x 600 mm

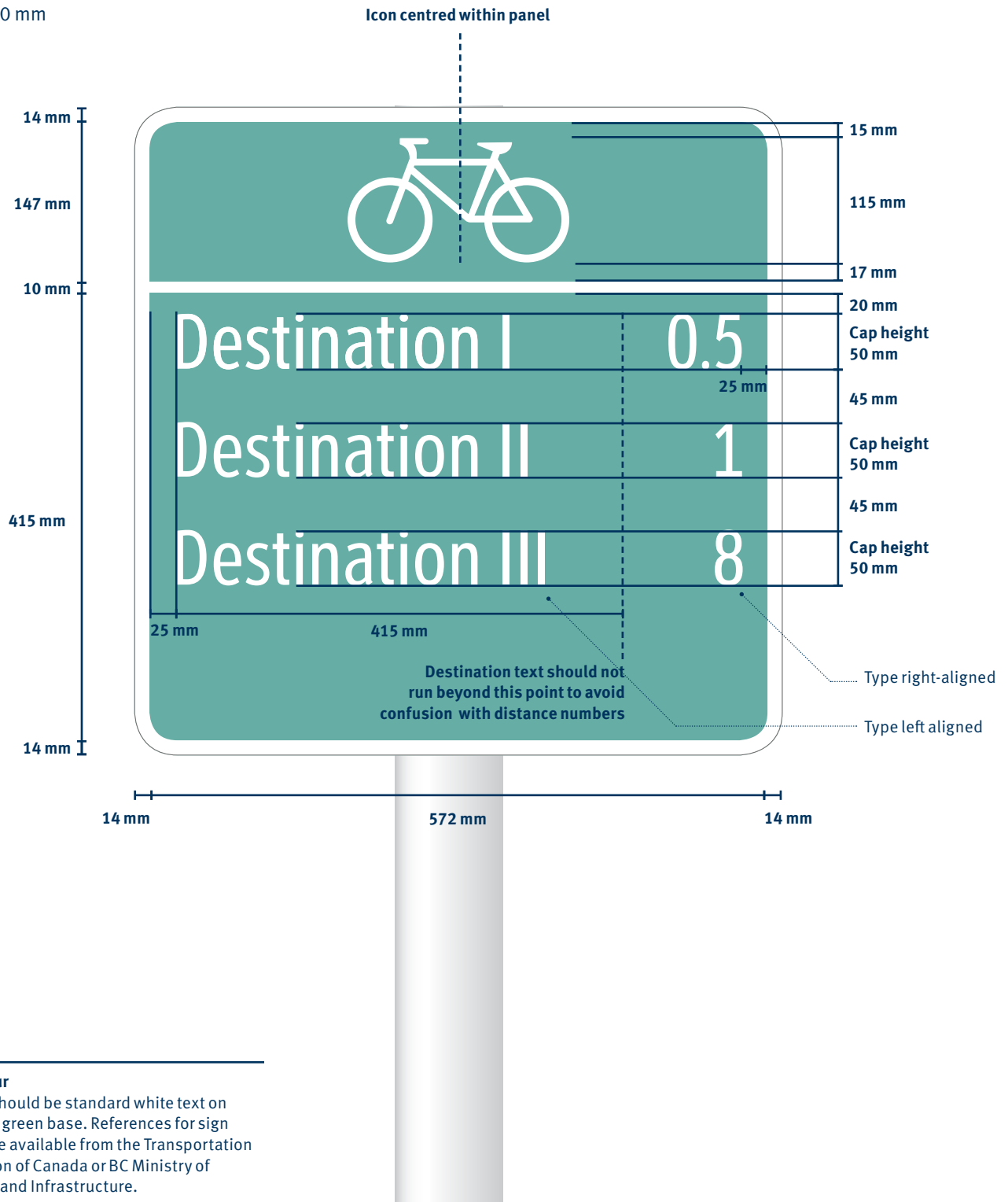

Sign colour

All signs should be standard white text on a highway green base. References for sign colours are available from the Transportation Association of Canada or BC Ministry of Highways and Infrastructure.



Standard elements

Bicycle icon



The bicycle icon should appear as shown. This icon should be consistent with TAC Bikeway Traffic Control Guidelines for Canada.

Icons



See page 45 for how to incorporate icons into signage.

Route codes

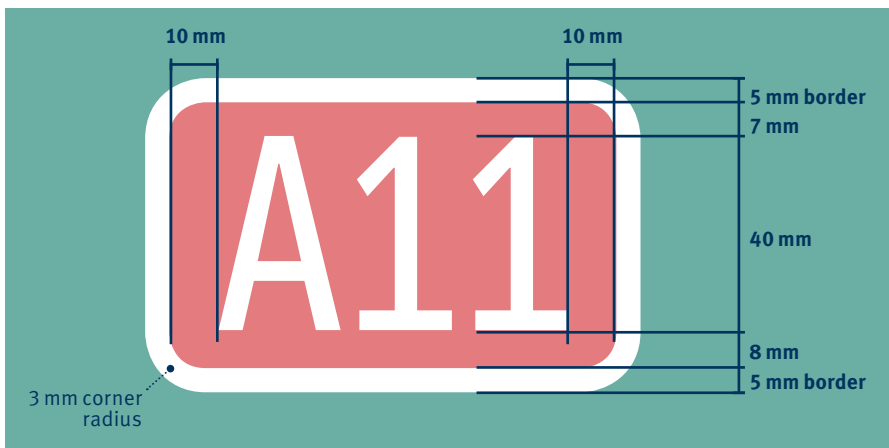

Route codes can be included in the header section of Confirmation signs. They should conform to the dimensions shown left.

See below for how to include them on the sign panel.

Adding route names and codes to the header section

Route names and codes can be displayed in the header section of the sign.

The header conforms to the same specification as the Decision sign. Refer to page 44–45 for dimensions and possible layouts.



Adding a subtext

Subtexts should be incorporated under the relevant destination name as shown. It should always be included on a second line, with a lowercase 'via'.

When adding a via subtext to a destination name that is already two lines, use the three-line specification shown opposite.

The top margin shown on previous pages of 20 mm is retained if the destination is at the top of the list.

If more than one destination name runs over two lines, the panel will have to be extended in height to 750 mm. All other dimensions are retained.

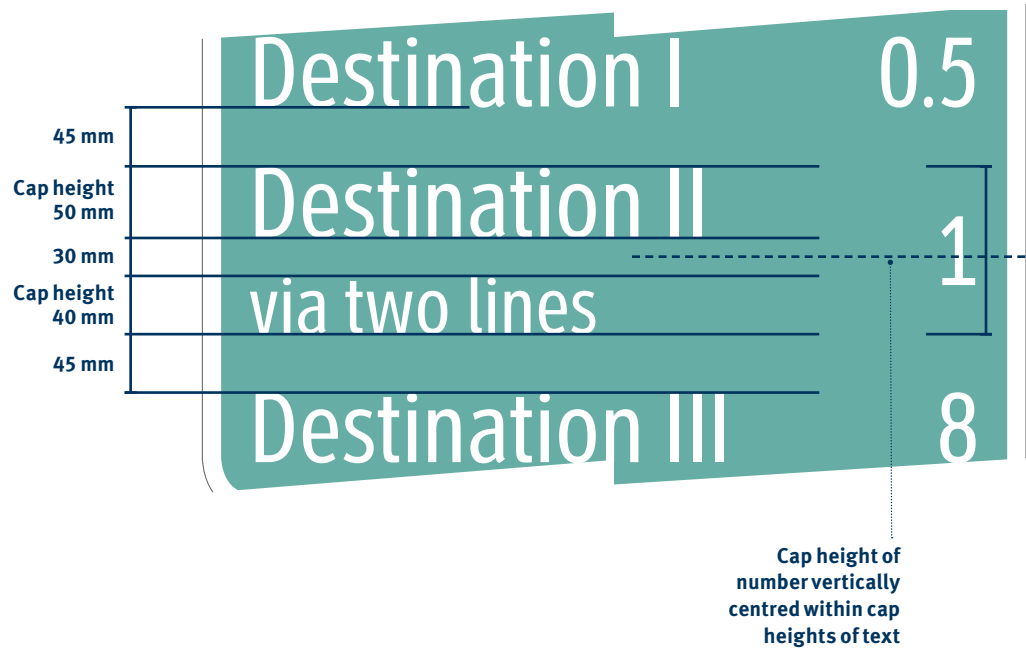

Destination names that run to two lines

Longer destination names may extend over two lines. This should be done as shown.

If more than one destination name runs over two lines, the panel will have to be extended in height to 750 mm. All other dimensions are retained.





Destination names that run to three lines

When there is more than one destination in a left or right direction, the standard dimensions should be altered to appear like this.

The dimensions of the ahead direction does not change.

Any dimensions not shown conform to the standard dimensions previously shown.

The illustration shows an example of a right direction. As previously, the left direction is a mirror image of the right direction, with dimensions measured from the left of the sign instead of the right.

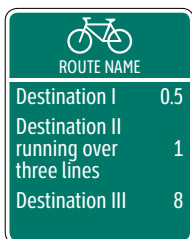

When a destination runs to three lines the panel should be extended to 750 mm in height. See page 40 for more information on sign sizes.

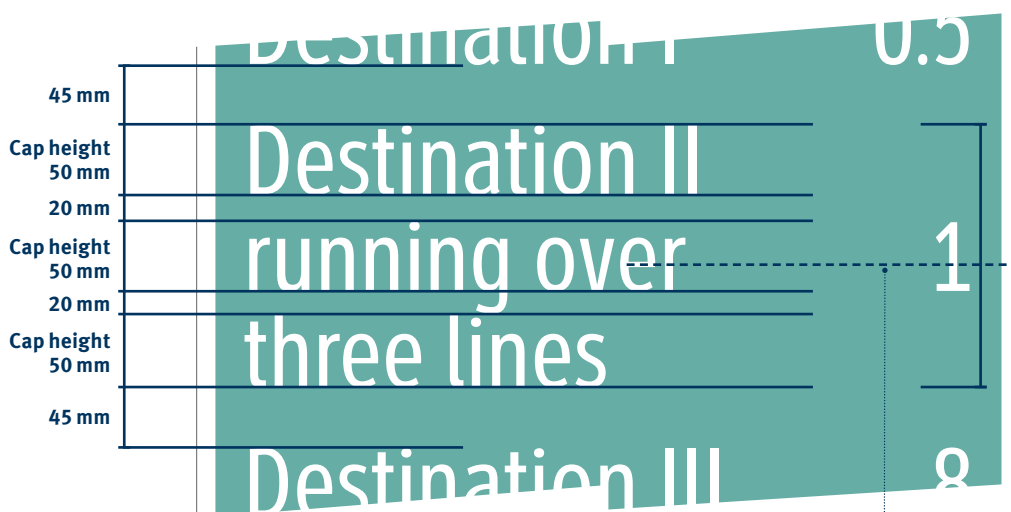

Cap height of number vertically centred within cap heights of text

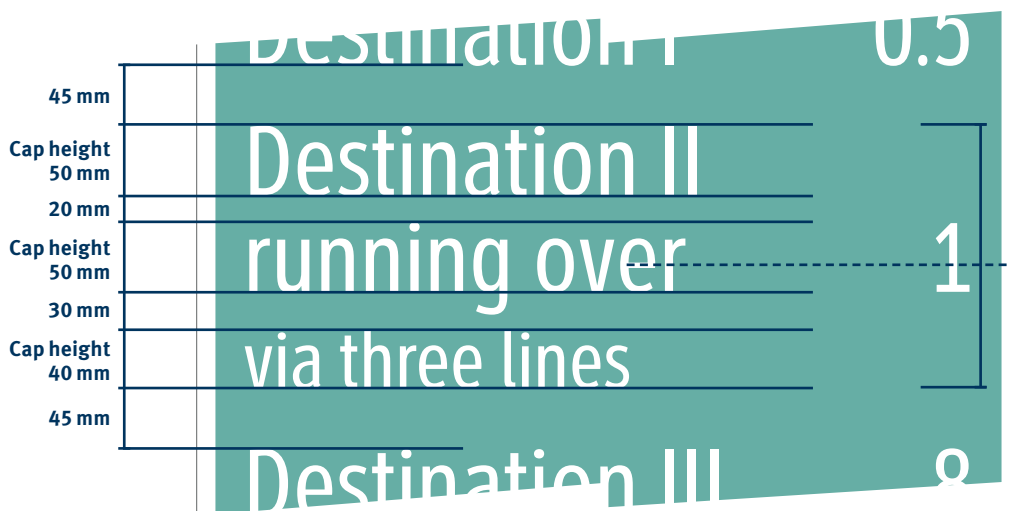

Standard Abbreviations

Generally abbreviations should be kept to a minimum. However where necessary the following standard abbreviations can be used to avoid lengthy destination names.

Station	=	Stn
Exchange	=	Exch
Bridge	=	Br

North	=	N
South	=	S
East	=	E
West	=	W

Shared paths



Shared paths may be indicated by the use of a special header. Commonly the route will be shared between cyclists and pedestrians, but headers can also indicate routes shared with horses or skaters.

These signs may be used in conjunction with TAC Shared Pathway Signs and pavement markings for traffic control and advice.

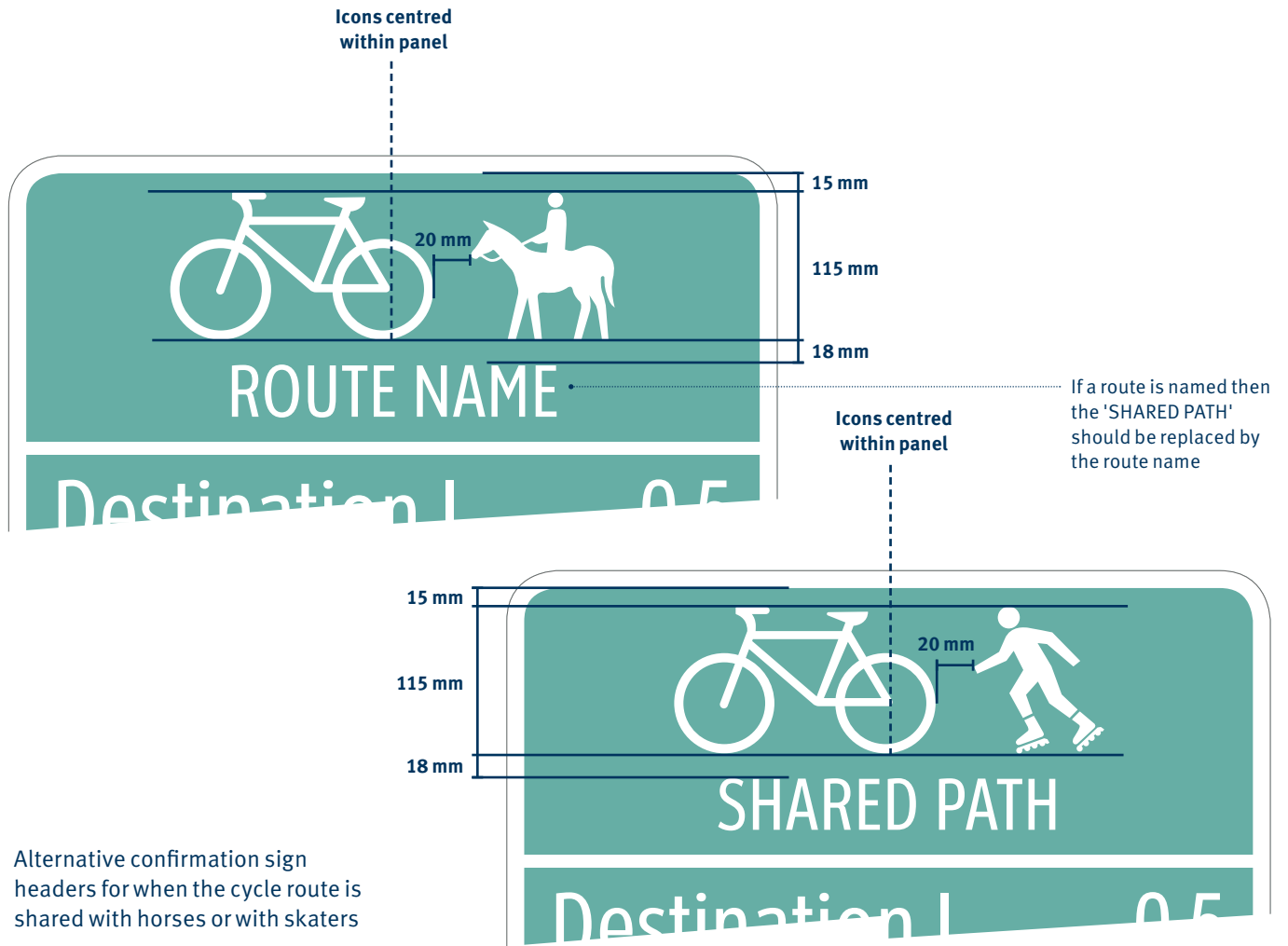

Icons



Icons should be consistent with TAC standards. Where TAC does not specify an icon for a given mode, the British Columbia Provincial Sign Program, Catalogue of Standard Traffic Signs may assist.

3.4.3 Turn Fingerboards

Standard dimensions

Panel size

850 x 215 mm

Destination text should not run beyond this point to avoid confusion with distance numbers



Chevron centred within panel

Type left aligned

Type right-aligned

Sign colour

All signs should be standard white text on a highway green base. References for sign colours are available from the Transportation Association of Canada or BC Ministry of Highways and Infrastructure.



Where space permits, end-fitted fingerboards present a more aesthetic arrangement that also increases the directional sense of the sign

Fingerboards should take the form shown.

This layout is the standard layout with two single line destinations on each fingerboard.

Further variation with single destinations and multiple line destinations are shown on the following pages

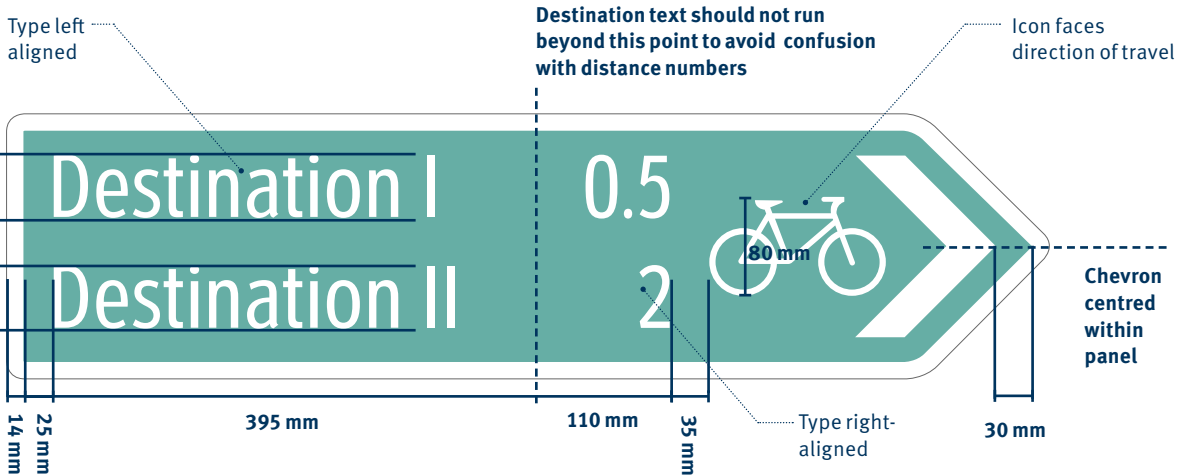

Standard elements

Bicycle icon



The bicycle icon should appear as shown. This icon should be consistent with TAC Bikeway Traffic Control Guidelines for Canada. The bicycle should face the direction of travel.

Icons



See page 43 for how to incorporate icons into signage.

Route codes

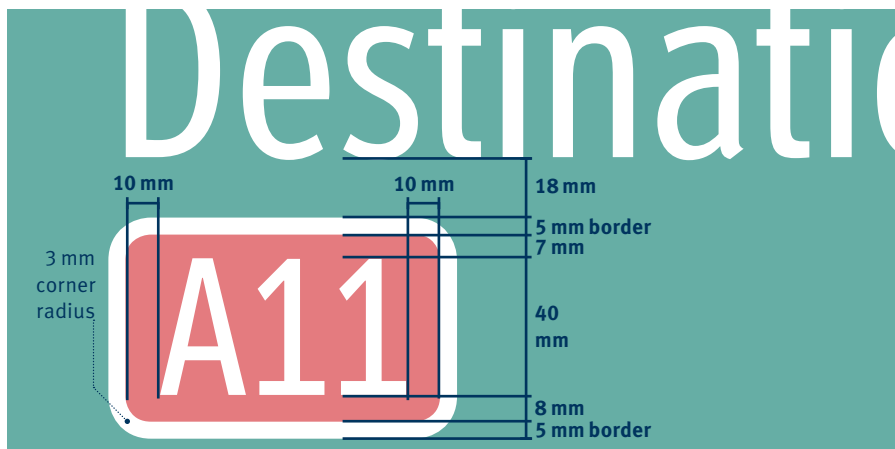

Coded routes should be shown in the way demonstrated, with the code appearing on a second line below the relevant destination name. See page 62 for guidance on including two-line destination names.

Code should be left or right-aligned according to alignment of text.

Fingerboards with only one destination

Panel size

850 x 215 mm

1 line destination



1 line destination with subtext

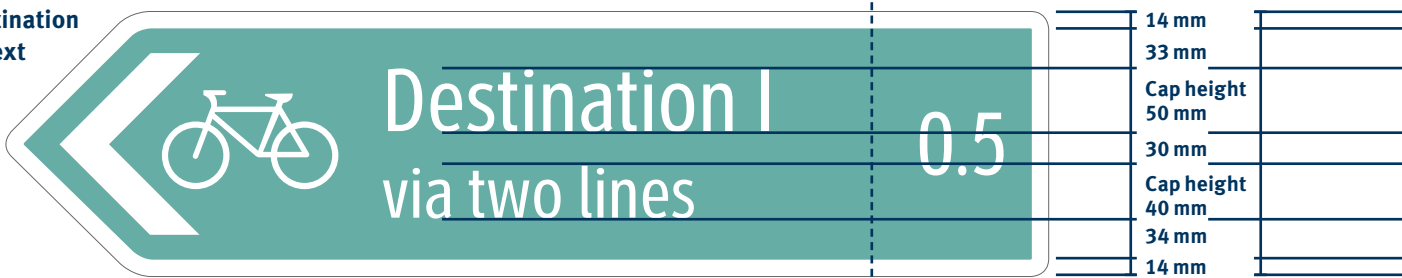

2 line destination



Destination text should not run beyond this point to avoid confusion with distance numbers

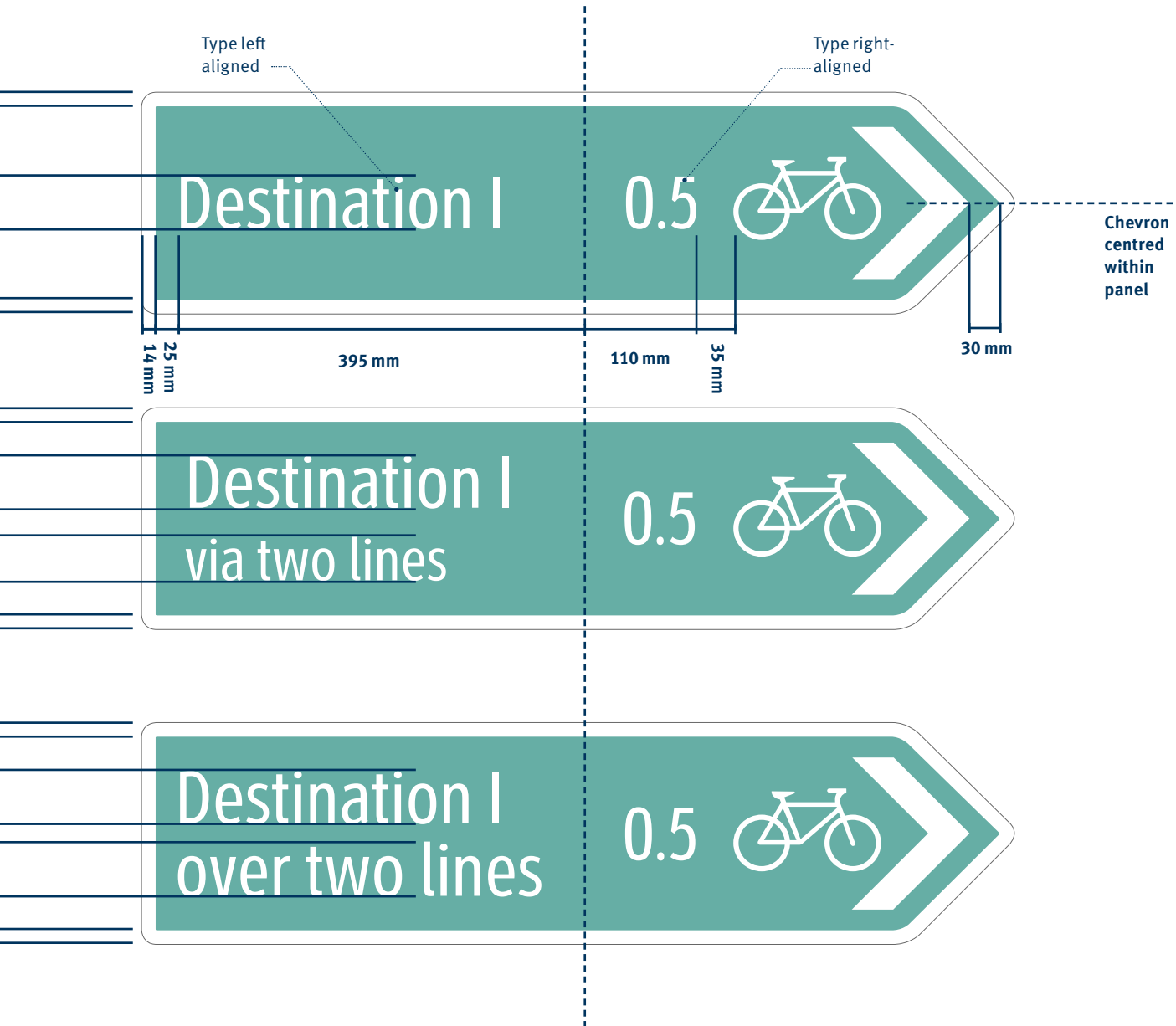

Destination text should not run beyond this point to avoid confusion with distance numbers

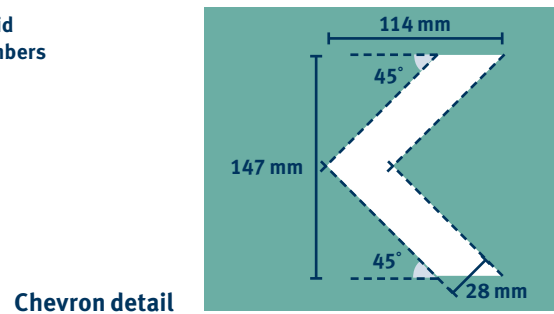

Fingerboards with two and three-line destinations and subtexts

Panel size
850 x 285 mm

Distance number cap height centred within destination name cap heights

1 and 2 line destinations

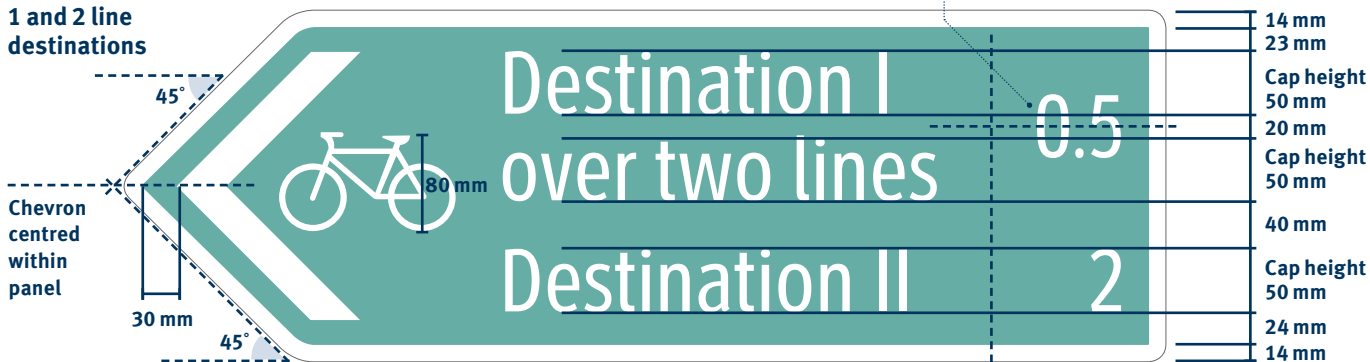

2 line destination with subtext



3 line destination



Type left aligned

Destination text should not run beyond this point to avoid confusion with distance numbers

Type right-aligned

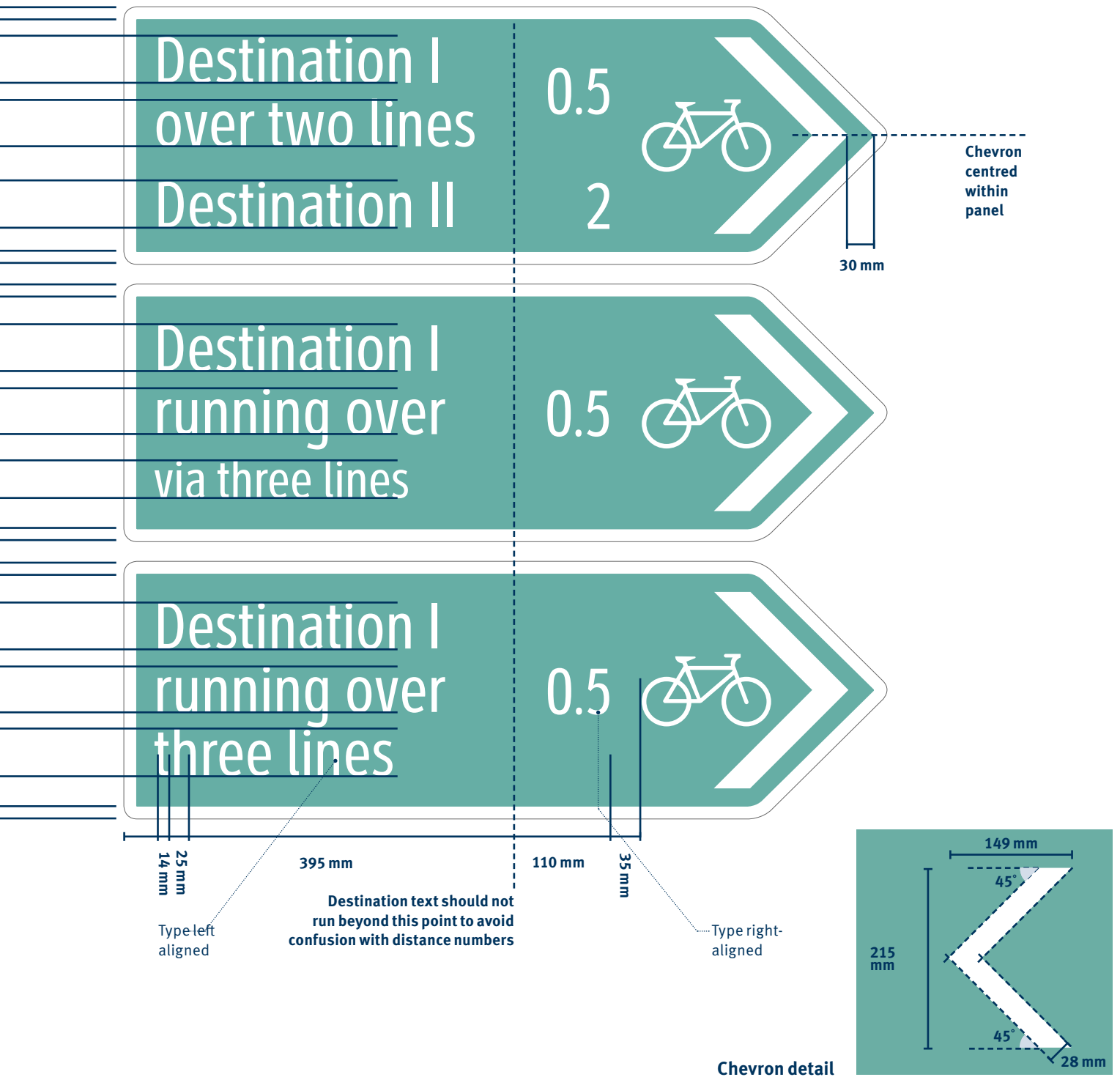

Fingerboards with more than one, two-line destinations

Panel size
850 x 350 mm

Two 2 line destinations

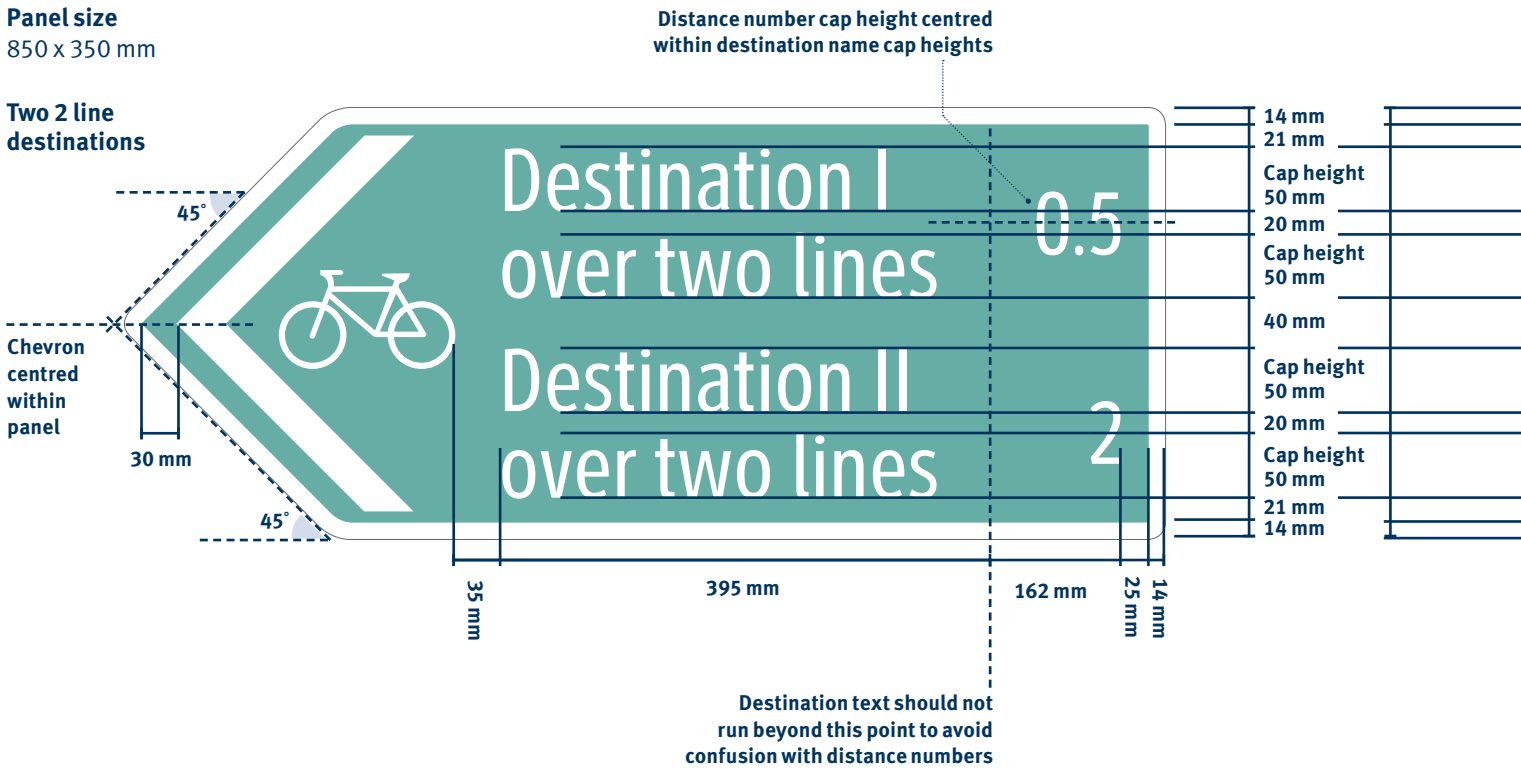

Standard Abbreviations

Generally abbreviations should be kept to a minimum. However where necessary the following standard abbreviations can be used to avoid lengthy destination names.

Station = Stn

Exchange = Exch

Bridge = Br

North = N

South = S

East = E

West = W

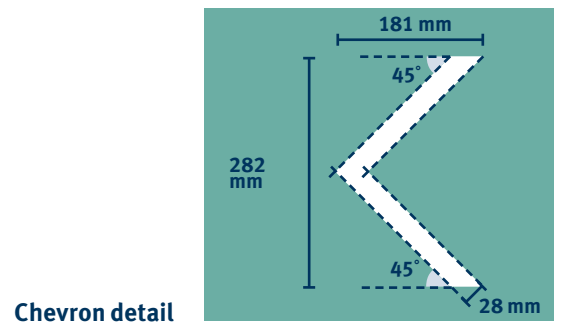
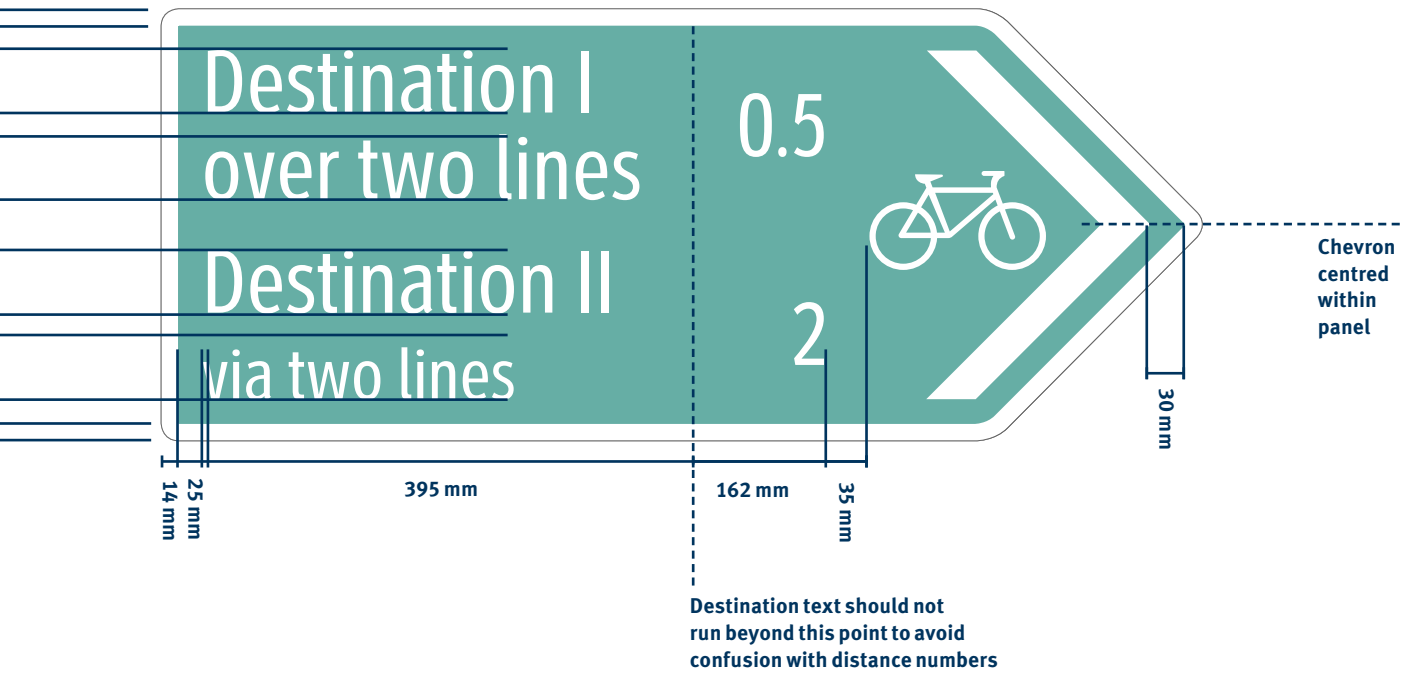

3.4.4 Off-network Waymarkers

Standard dimensions

Directional chevron

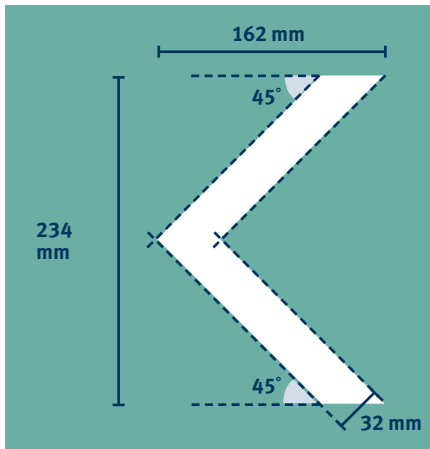

Bicycle icon



The bicycle icon should appear as shown. This icon should be consistent with TAC Bikeway Traffic Control Guidelines for Canada.

The bicycle should face the direction of travel.

Panel size
300 x 450 mm

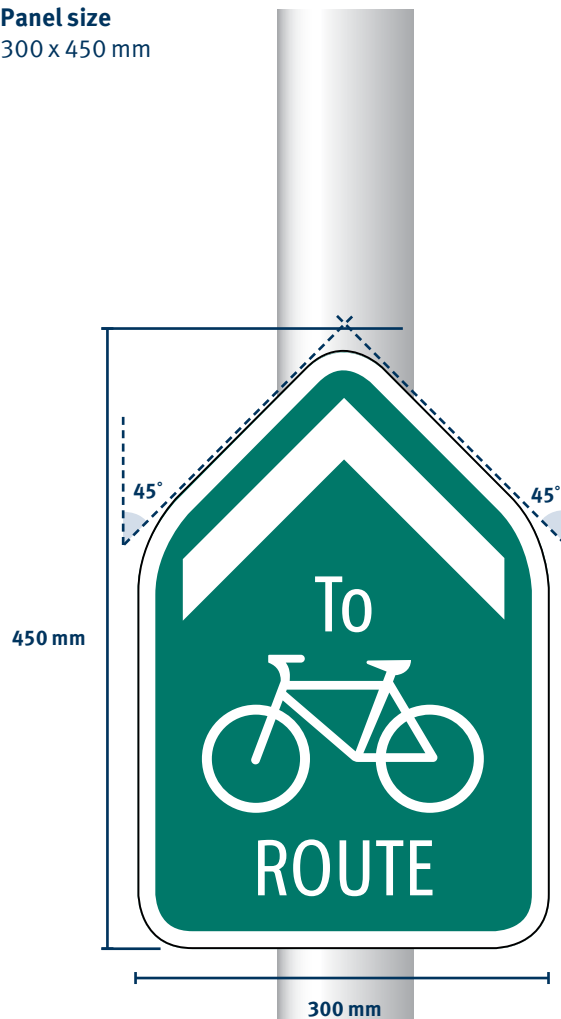

Sign colour

All signs should be standard white text on a highway green base. References for sign colours are available from the Transportation Association of Canada or BC Ministry of Highways and Infrastructure.

Off-network Waymarkers should take this form, with variation in directions (ahead, left and right) and route name length (one or two lines) shown over opposite.

On a named route, the name should take the place of the words 'bike route' shown in the illustrations.



Text and bicycle icon dimensions

Ahead direction

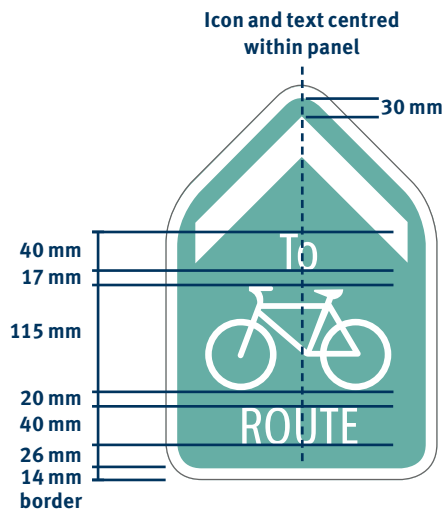

Left direction

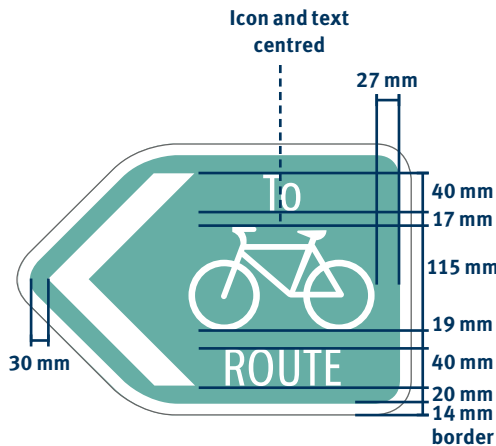

Right direction

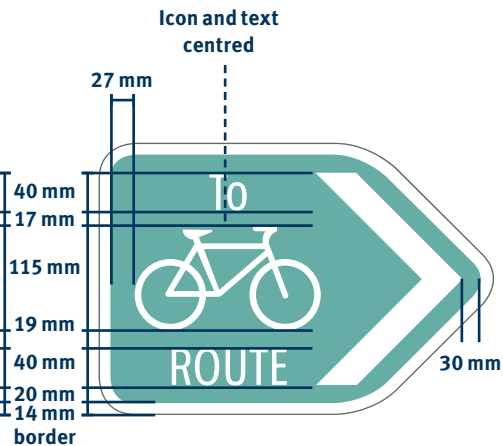

3.4.5 Pavement Markings

Where bicycle routing is complex, or where effective sign placement is challenging, pavement markings can be useful supplements to wayfinding signage. Because pavement markings are not always visible due to weather conditions or surface debris, they should be used in conjunction with signage rather than as a replacement.

Standard elongated bicycle symbols are recommended for on-street pavement markings, because they are designed to mark bicycle facilities in a way that will be legible to motor vehicle drivers as well as cyclists. However, the route code is not elongated because it is only relevant to cyclists, who have slower travel speeds and different viewing angles. Where the facility is for bicycles only, and signage is not viewed by motor vehicle drivers, elongation of pavement markings is not required if there is no risk of confusion for drivers.

A bicycle symbol combined with an arrow provides information about where cycling is allowed, and in what direction. Examples show arrows consistent with those on Decision Signs. However, municipalities may exercise discretion in choice of arrow style for pavement marking. When guiding cyclists along a path that leads exclusively to bicycle parking facilities, the TAC bicycle parking icon can be combined with an arrow as shown. Route coding, if adopted, can also be incorporated into the pavement marking.

Off-street pavement marking options

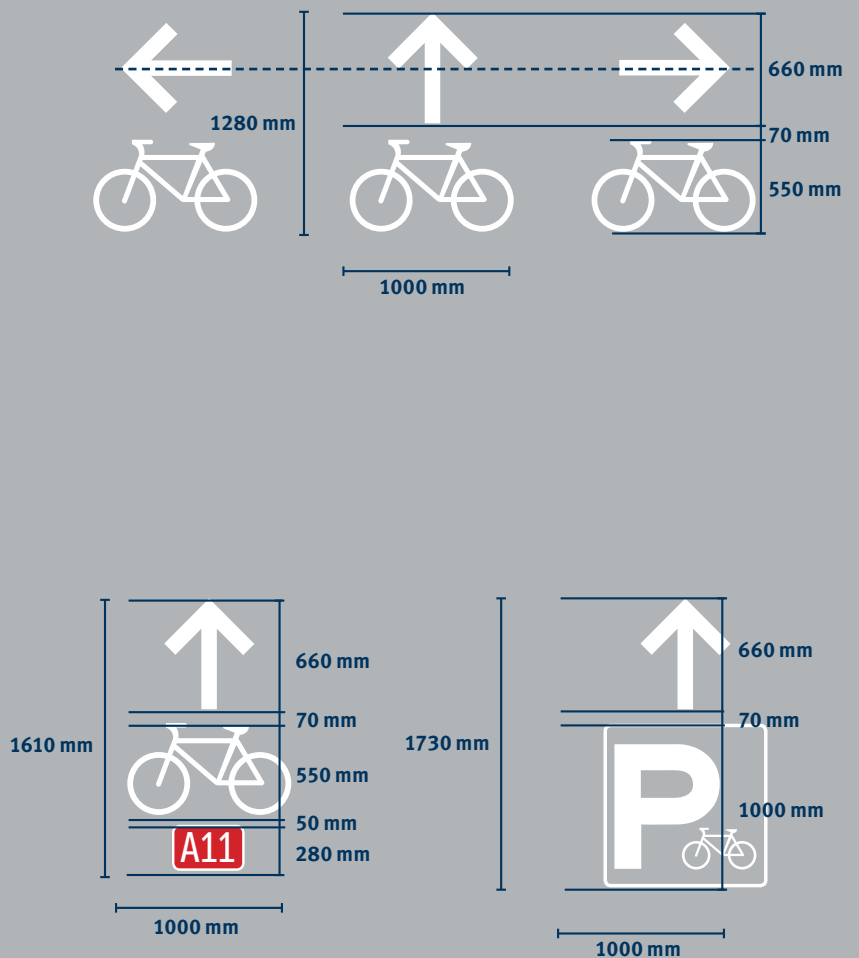

3.4.6 Specifying for manufacture

Metro Vancouver municipalities determine their own standards for signage products. Specifications for materials, reflectivity, mounting and installation methods should be added to the agreed sign schedule in a manner appropriate to the application and relevant local, provincial and national sign production standards.

On-street pavement marking options

Icons elongated by 2:1

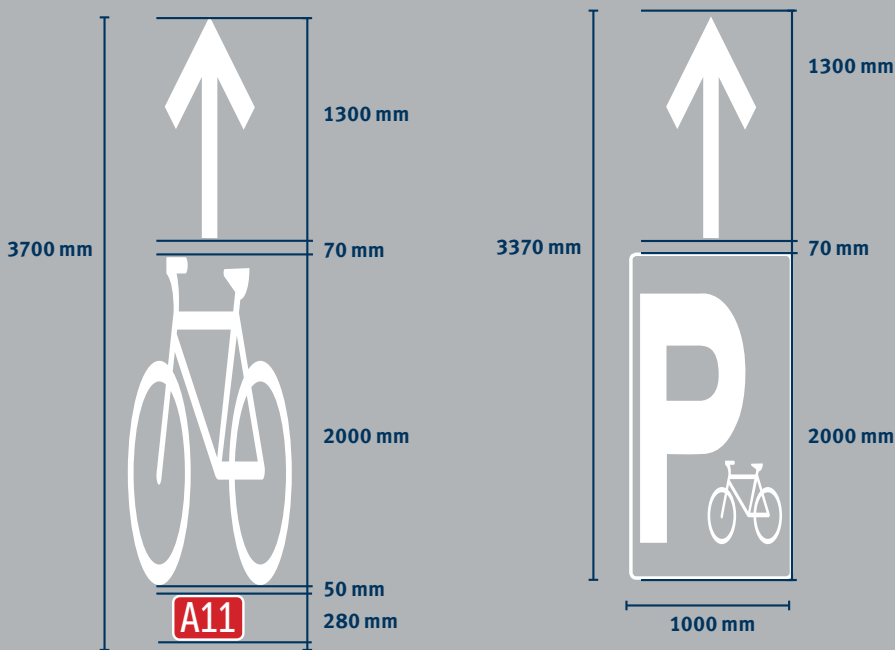
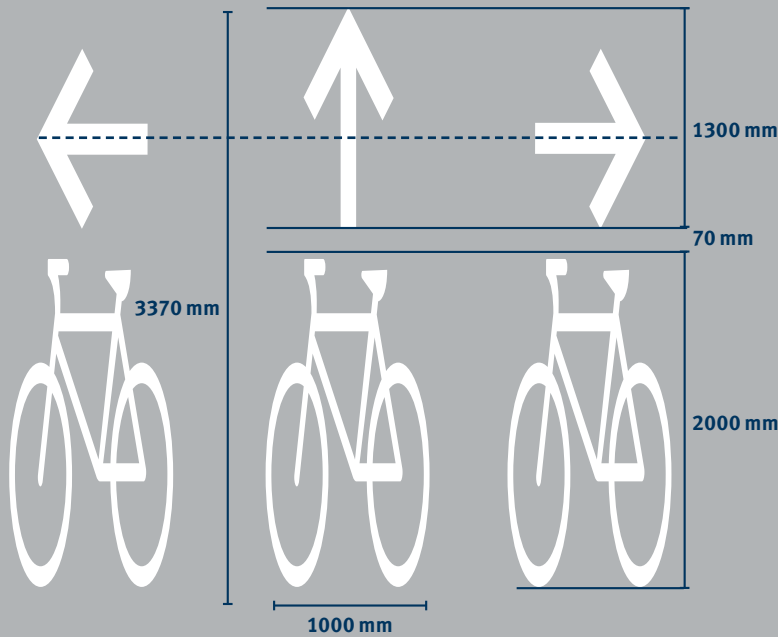

Bicycle Boulevard Markings Placement

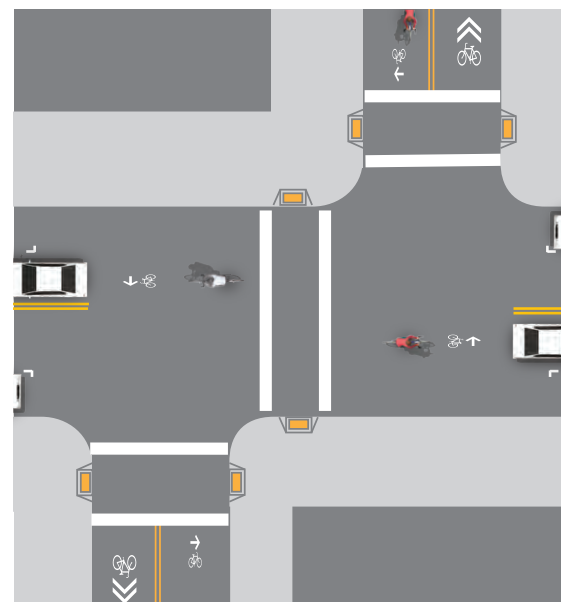

Destination I



Destinatio
Destinatio

Appendices

- 1 Regional Bicycle Wayfinding Destination Schedule
- 2 Route Naming Advice
- 3 Specific Applications
- 4 Summary of Bicycle Wayfinding Best Practice Review
- 5 Template Guide



Appendix 1

Regional Bicycle Wayfinding Destination Schedule

The list overleaf is an agreed schedule of destinations across the Metro Vancouver region for bicycle wayfinding.

With the exception of discretionary Level 4 Local Attractions, only these destinations should be used.

Standard abbreviations

Generally abbreviations should be kept to a minimum. However where necessary the following standard abbreviations can be used to avoid lengthy destination names. Standard abbreviations are listed below:

Station = Stn

Exchange = Exch

Bridge = Br

North = N

South = S

East = E

West = W

Level 1 destinations – Urban Centres

Municipality	Destination Name	Distance Measured To	Basis for Inclusion
Burnaby	Brentwood	Outer boundary	Regional Growth Strategy
Burnaby	Edmonds	Outer boundary	Regional Growth Strategy
Burnaby	Lougheed	Outer boundary	Regional Growth Strategy
Burnaby	Metrotown	Outer boundary	Regional Growth Strategy
Burnaby	SFU	Outer boundary	Regional Growth Strategy
Coquitlam	Coquitlam City Centre	Outer boundary	Regional Growth Strategy
Delta	Ladner	Outer boundary	Regional Growth Strategy
Electoral Area A	UBC	Outer boundary	Regional Growth Strategy
Langley City	City of Langley	Outer boundary	Regional Growth Strategy
Langley Township	Aldergrove	Outer boundary	Regional Growth Strategy
Langley Township	Willowbrook Town Centre	Outer boundary	Regional Growth Strategy
Maple Ridge	Maple Ridge Town Centre	Outer boundary	Regional Growth Strategy
New Westminster	Downtown New Westminster (may be shortened to 'Downtown New West')	Outer boundary	Regional Growth Strategy
North Vancouver City	Central Lonsdale	Outer boundary	Regional Growth Strategy
North Vancouver City	Lower Lonsdale	Outer boundary	Regional Growth Strategy
North Vancouver District	Lynn Valley Town Centre	Outer boundary	Regional Growth Strategy
Pitt Meadows	Pitt Meadows	Outer boundary	Regional Growth Strategy
Port Coquitlam	Port Coquitlam Town Centre	Outer boundary	Regional Growth Strategy
Port Moody	Port Moody Town Centre	Outer boundary	Regional Growth Strategy
Richmond	Richmond City Centre	Outer boundary	Regional Growth Strategy
Surrey	Cloverdale Town Centre	Outer boundary	Regional Growth Strategy
Surrey	Fleetwood Town Centre	Outer boundary	Regional Growth Strategy
Surrey	Guildford Town Centre	Outer boundary	Regional Growth Strategy
Surrey	Newton Town Centre	Outer boundary	Regional Growth Strategy
Surrey	Semiahmoo Town Centre	Outer boundary	Regional Growth Strategy
Surrey	Surrey City Centre	Outer boundary	Regional Growth Strategy
Vancouver	Downtown Vancouver	Outer boundary	Regional Growth Strategy
Vancouver	Oakridge	Outer boundary	Regional Growth Strategy
West Vancouver	Ambleside	Outer boundary	Regional Growth Strategy

Level 2 destinations – Local Neighbourhoods

Municipality	Destination Name	Distance Measured To	Basis for Inclusion
Anmore	Anmore	Contact municipality	OCP
Belcarra	Belcarra	Contact municipality	OCP
Belcarra	Belcarra Bay	Contact municipality	OCP
Burnaby	Bainbridge (future)	Lougheed Hwy & Bainbridge Ave	OCP – Urban Village
Burnaby	Brighton	Government Rd/Winston St & Brighton Ave	OCP – Urban Village
Burnaby	Broadview	Canada Way & Smith Ave	OCP – Urban Village
Burnaby	Capitol Hill	Hastings St & Sperling Ave	OCP – Urban Village
Burnaby	Cascade Heights	Sunset St & Smith Ave	OCP – Urban Village
Burnaby	Heights	Willingdon Ave & Hastings St	OCP – Urban Village
Burnaby	Holdom	Lougheed Hwy & Holdom Ave	OCP – Urban Village
Burnaby	Lochdale	Hastings St & Kensington Ave	OCP – Urban Village
Burnaby	Montecito	Philips Ave & Greystone Dr	OCP – Urban Village
Burnaby	Royal Oak	Royal Oak Ave & Rumble St	OCP – Urban Village
Burnaby	Sixth Street	6 St & Graham Ave	OCP – Urban Village
Burnaby	Willingdon Heights	Madison Ave & Williams St	OCP – Urban Village
Coquitlam	Austin Heights	Contact municipality	OCP
Coquitlam	Austin Mariner	Contact municipality	OCP
Coquitlam	Burquitlam	Contact municipality	OCP
Coquitlam	Como Lake Village	Contact municipality	OCP
Coquitlam	Fraser Mills	Contact municipality	OCP
Coquitlam	Lower Lougheed	Contact municipality	OCP
Coquitlam	Maillardville	Contact municipality	OCP
Coquitlam	Partington Creek Village	Contact municipality	OCP
Coquitlam	Poirier	Contact municipality	OCP
Coquitlam	Westwood Plateau	Contact municipality	OCP
Delta	North Delta	Contact municipality	OCP
Delta	Tsawwassen	Contact municipality	OCP
Electoral Area A	Wesbrook Village	Contact municipality	UBC Campus Plan
Langley City	Alice Brown	200 St & 44 Ave	OCP

Level 2 destinations – Local Neighbourhoods (cont'd)

Municipality	Destination Name	Distance Measured To	Basis for Inclusion
Langley City	Blacklock	207 St & 51B Ave	OCP
Langley City	Douglas	206 St & Douglas Cres	OCP
Langley City	Nicomekl	200 St & 53 Ave	OCP
Langley City	Simonds	48 Ave & 201 St	OCP
Langley City	Uplands	206 St & 45 Ave	OCP
Langley Township	Brookwood	Contact municipality	OCP
Langley Township	Fort Langley	Contact municipality	OCP
Langley Township	Murrayville	Contact municipality	OCP
Langley Township	Walnut Grove	Contact municipality	OCP
Langley Township	Willoughby	Contact municipality	OCP
Lions Bay	Lions Bay	Contact municipality	OCP
New Westminster	Brow of the Hill	Contact municipality	Resident's Assoc.
New Westminster	Connaught Heights	Contact municipality	Resident's Assoc.
New Westminster	Glenbrooke North	Contact municipality	Resident's Assoc.
New Westminster	Massey–Victory Heights	Contact municipality	Resident's Assoc.
New Westminster	McBride–Sapperton	Contact municipality	Resident's Assoc.
New Westminster	Moody Park	Contact municipality	Resident's Assoc.
New Westminster	Quayside	Contact municipality	Resident's Assoc.
New Westminster	Queensborough	Contact municipality	Resident's Assoc.
New Westminster	Queen's Park	Contact municipality	Resident's Assoc.
New Westminster	West End	Contact municipality	Resident's Assoc.
North Vancouver City	Cedar Village	Contact municipality	OCP
North Vancouver City	Grand Boulevard	Contact municipality	OCP
North Vancouver City	Habourside	Contact municipality	OCP
North Vancouver City	Mahon	Contact municipality	OCP
North Vancouver City	Marine–Hamilton	Contact municipality	OCP
North Vancouver City	Moodyville	Contact municipality	OCP
North Vancouver City	Tempe	Contact municipality	OCP
North Vancouver City	Westview	Contact municipality	OCP
North Vancouver District	Lower Capilano–Marine Village	Contact municipality	OCP
North Vancouver District	Lower Lynn Town Centre	Contact municipality	OCP
North Vancouver District	Maplewood Village	Contact municipality	OCP

Level 2 destinations – Local Neighbourhoods (cont'd)

Municipality	Destination Name	Distance Measured To	Basis for Inclusion
Port Coquitlam	Dominion Triangle	Contact municipality	OCP
Port Coquitlam	Northside	Contact municipality	OCP
Port Coquitlam	Westwood	Contact municipality	OCP
Port Moody	College Park	Contact municipality	OCP
Port Moody	Glenayre	Contact municipality	OCP
Port Moody	Heritage Mountain	Contact municipality	OCP
Port Moody	Heritage Woods	Contact municipality	OCP
Port Moody	loco Station	Barnet Hwy & loco Rd	OCP
Port Moody	loco Townsite	Contact municipality	OCP
Port Moody	Moody Central Station	65 Williams St	OCP
Port Moody	Newport Village	260 Newport Dr	OCP
Port Moody	Suter Brook Village	Suter Brook Way & Brew St	OCP
Pitt Meadows	Osprey Village	Contact municipality	Local Plan
Richmond	Blundell	Contact municipality	OCP
Richmond	Bridgeport	Contact municipality	OCP
Richmond	Broadmoor	Contact municipality	OCP
Richmond	East Cambie	Contact municipality	OCP
Richmond	East Richmond	Contact municipality	OCP
Richmond	Fraserport	Contact municipality	OCP
Richmond	Hamilton	Contact municipality	OCP
Richmond	Ironwood	Contact municipality	OCP
Richmond	Seafair	Contact municipality	OCP
Richmond	Sea Island	Contact municipality	OCP
Richmond	South Richmond	Contact municipality	OCP
Richmond	Steveston	Contact municipality	OCP
Richmond	Terra Nova	Contact municipality	OCP
Richmond	West Cambie	Contact municipality	OCP
Surrey	Bolivar Heights	Contact municipality	OCP
Surrey	Bridgeview	Contact municipality	OCP
Surrey	Campbell Heights	Contact municipality	OCP
Surrey	Crescent Beach	Contact municipality	OCP
Surrey	Douglas	Contact municipality	OCP

Level 2 destinations – Local Neighbourhoods (cont'd)

Municipality	Destination Name	Distance Measured To	Basis for Inclusion
Surrey	East Clayton	Contact municipality	OCP
Surrey	Fraser Heights	Contact municipality	OCP
Surrey	Grandview Heights	Contact municipality	OCP
Surrey	Morgan Heights	Contact municipality	OCP
Surrey	Ocean Park	Contact municipality	OCP
Surrey	Panorama Ridge	Contact municipality	OCP
Surrey	Port Kells	Contact municipality	OCP
Surrey	Rosemary Heights	Contact municipality	OCP
Surrey	South Westminster	Contact municipality	OCP
Surrey	Strawberry Hill	Contact municipality	OCP
Surrey	Sunnyside Heights	Contact municipality	OCP
Vancouver	Chinatown	Pender midway between Main & Columbia	Local Plan
Vancouver	Collingwood	Kingsway & Joyce St	Local Plan
Vancouver	The Drive	Commercial & 1st Ave	Local Plan
Vancouver	Gastown	Maple Tree Sq	Local Plan
Vancouver	Granville Island	Anderson St & Railspur	Local Plan
Vancouver	Kerrisdale	Yew & 41st Ave	Local Plan
Vancouver	Kitsilano	Trafalgar & 4th Ave	Local Plan
Vancouver	Mount Pleasant	Main St & E Broadway	Local Plan
West Vancouver	Altamont	Contact municipality	OCP
West Vancouver	Bayridge	Contact municipality	OCP
West Vancouver	British Properties	Contact municipality	OCP
West Vancouver	Canterbury	Contact municipality	OCP
West Vancouver	Caulfeild	Contact municipality	OCP
West Vancouver	Cedarvale	Contact municipality	OCP
West Vancouver	Chartwell	Contact municipality	OCP
West Vancouver	Cypress Park	Contact municipality	OCP
West Vancouver	Dundarave	Contact municipality	OCP
West Vancouver	Eagle Harbour	Contact municipality	OCP
West Vancouver	Gleneagles	Contact municipality	OCP
West Vancouver	Glenmore	Contact municipality	OCP

Level 2 destinations – Local Neighbourhoods (cont'd)

Municipality	Destination Name	Distance Measured To	Basis for Inclusion
West Vancouver	Hollyburn	Contact municipality	OCP
West Vancouver	Horsehoe Bay	Contact municipality	OCP
West Vancouver	Sentinel Hill	Contact municipality	OCP
West Vancouver	Westmount	Contact municipality	OCP
West Vancouver	Whitby Panorama	Contact municipality	OCP
West Vancouver	Whytecliff	Contact municipality	OCP
White Rock	Waterfront	Contact municipality	OCP
White Rock	White Rock town centre	Contact municipality	OCP

Level 3 destinations – Major Attractions – Parks

Municipality	Destination Name	Distance Measured To	Basis for Inclusion
Belcarra	Belcarra Regional Park	Cyclist's arrival point	Metro Vancouver Parks
Burnaby	Barnet Marine Park	Cyclist's arrival point	Municipality
Burnaby	Burnaby Fraser Foreshore Park	Cyclist's arrival point	Municipality
Burnaby	Burnaby Lake Regional Park	Cyclist's arrival point	Metro Vancouver Parks
Burnaby	Burnaby Mountain Conservation Area	Cyclist's arrival point	Municipality
Burnaby	Central Park	Cyclist's arrival point	Municipality
Burnaby	Deer Lake Park	Cyclist's arrival point	Municipality
Bowen Island	Crippen Regional Park	Cyclist's arrival point	Metro Vancouver Parks
Coquitlam	Colony Farm Regional Park	Cyclist's arrival point	Metro Vancouver Parks
Coquitlam	Minnekhada Regional Park	Cyclist's arrival point	Metro Vancouver Parks
Coquitlam	Town Centre Park	Cyclist's arrival point	Municipality
Delta	Boundary Bay Regional Park	Cyclist's arrival point	Metro Vancouver Parks
Delta	Burns Bog Regional Park	Cyclist's arrival point	Metro Vancouver Parks
Delta	Deas Island Regional Park	Cyclist's arrival point	Metro Vancouver Parks
Delta	George C. Reifel Migratory Bird Sanctuary	Cyclist's arrival point	BC Waterfowl Society
Delta	Watershed Park	Cyclist's arrival point	Municipality
Electoral Area A	Pacific Spirit Regional Park	Cyclist's arrival point	Metro Vancouver Parks
Langley Township	Brae Island Regional Park	Cyclist's arrival point	Metro Vancouver Parks
Langley Township	Campbell Valley Regional Park	Cyclist's arrival point	Metro Vancouver Parks
Langley Township	Derby Reach Regional Park	Cyclist's arrival point	Metro Vancouver Parks

Level 3 destinations – Major Attractions – Parks (cont'd)

Municipality	Destination Name	Distance Measured To	Basis for Inclusion
Langley Township	Glen Valley Regional Park	Cyclist's arrival point	Metro Vancouver Parks
Maple Ridge	Golden Ears Provincial Park	Cyclist's arrival point	BC Parks
Maple Ridge	Kanaka Creek Regional Park	Cyclist's arrival point	Metro Vancouver Parks
Maple Ridge	Merkly Park	Cyclist's arrival point	Municipality
Maple Ridge	Maple Ridge Park	Cyclist's arrival point	Municipality
Maple Ridge	Whonnock Lake	Cyclist's arrival point	Municipality
North Vancouver City	Mahon Park	Cyclist's arrival point	Municipal
North Vancouver District	Capilano River Regional Park	Cyclist's arrival point	Metro Vancouver Parks
North Vancouver District	Lower Seymour Conservation Reserve	Cyclist's arrival point	Metro Vancouver Parks
North Vancouver District	Lynn Canyon Park	Cyclist's arrival point	Municipality
North Vancouver District	Lynn Headwaters Regional Park	Cyclist's arrival point	Metro Vancouver Parks
North Vancouver District	Mount Seymour Provincial Park	Cyclist's arrival point	BC Parks
Port Coquitlam	Colony Farm Regional Park	Cyclist's arrival point	Metro Vancouver Parks
Richmond	Iona Beach Regional Park	Cyclist's arrival point	Metro Vancouver Parks
Surrey	Bear Creek Park	Cyclist's arrival point	Municipality
Surrey	Blackie Spit	Cyclist's arrival point	Municipality
Surrey	Colebrook Park	Cyclist's arrival point	Municipality
Surrey	Crescent Park	Cyclist's arrival point	Municipality
Surrey	Darts Hill Garden Park	Cyclist's arrival point	Municipality
Surrey	Green Timbers Urban Forest	Cyclist's arrival point	Municipality
Surrey	Peace Arch Provincial Park	Cyclist's arrival point	BC Parks
Surrey	Redwood Park	Cyclist's arrival point	Municipality
Surrey	Serpentine Fen	Cyclist's arrival point	Municipality
Surrey	Surrey Bend Regional Park	Cyclist's arrival point	BC Parks
Surrey	Sunnyside Acres Urban Forest	Cyclist's arrival point	Municipality
Surrey	Tynehead Regional Park	Cyclist's arrival point	Metro Vancouver Parks
Vancouver	Stanley Park	Cyclist's arrival point	BC Parks
Vancouver	Queen Elizabeth Park	Cyclist's arrival point	Municipality
West Vancouver	Cypress Provincial Park	Cyclist's arrival point	BC Parks
West Vancouver	Lighthouse Park	Cyclist's arrival point	Municipality

Level 3 destinations – Major Attractions – Trails

Municipality	Destination Name	Distance Measured To	Basis for Inclusion
Coquitlam	Poco Trail	Cyclist's arrival point	Municipality
Langley City	Nicomekl Flood Plain Trails	Cyclist's arrival point	Municipality
Metro Vancouver	Boundary Bay Dyke Trail	Cyclist's arrival point	Regional
Metro Vancouver	Experience the Fraser Canyon to Coast Trail	Cyclist's arrival point	Regional
Metro Vancouver	Pitt River Regional Greenway	Cyclist's arrival point	Regional
North Vancouver City	North Shore Spirit Trail (where not MBN)	Cyclist's arrival point	Municipality
Port Coquitlam	Poco Trail	Cyclist's arrival point	Municipality
Richmond	Middle Arm Trail	Cyclist's arrival point	Municipality
Richmond	South Dyke Trail	Cyclist's arrival point	Municipality
Richmond	West Dyke Trail	Cyclist's arrival point	Municipality
Surrey	Semiahmoo Trail	Cyclist's arrival point	Municipality
Tsawwassen	Tsawwassen First Nations Dyke Trail	Cyclist's arrival point	Municipality
Vancouver	Seaside Greenway	Cyclist's arrival point	Municipality
N/a	Trans Canada Trail	Cyclist's arrival point	National

Level 3 destinations – Transit Stations and Exchanges

Municipality	Destination Name	Distance Measured To	Basis for Inclusion
Burnaby	Brentwood Town Centre Station	Station	TransLink
Burnaby	Edmonds Station	Station	TransLink
Burnaby	Gilmore Station	Station	TransLink
Burnaby	Holdom Station	Station	TransLink
Burnaby	Lake City Station	Station	TransLink
Burnaby	Lougheed Town Centre Station	Station	TransLink
Burnaby	Metrotown Station	Station	TransLink
Burnaby	Patterson Station	Station	TransLink
Burnaby	Production Way–University	Station	TransLink
Burnaby	SFU Exchange	Bus exchange	TransLink
Burnaby	Sperling–Burnaby Lake Station	Station	TransLink

Level 3 destinations – Transit Stations and Exchanges (Cont'd)

Municipality	Destination Name	Distance Measured To	Basis for Inclusion
Coquitlam	Coquitlam Central Station	Station	TransLink
Delta	Ladner Exchange	Bus exchange	TransLink
Langley City	Langley Centre	Bus exchange	TransLink
Langley Township	Carvolth Exchange	Bus exchange	TransLink
Maple Ridge	Haney Place Exchange	Bus exchange	TransLink
Maple Ridge	Maple Meadows Station	Station	TransLink
Maple Ridge	Port Haney Station	Station	TransLink
Mission	Mission Station	Station	TransLink
New Westminster	22nd Street Station	Station	TransLink
New Westminster	Braid Station	Station	TransLink
New Westminster	Columbia Station	Station	TransLink
New Westminster	New Westminster Station	Station	TransLink
New Westminster	Sapperton Station	Station	TransLink
North Vancouver City	Lonsdale Quay SeaBus Terminal	Bus exchange	TransLink
North Vancouver District	Edgemont Village Exchange	Bus exchange	TransLink
North Vancouver District	Phibbs Exchange	Bus exchange	TransLink
Pitt Meadows	Pitt Meadows Station	Station	TransLink
Pitt Meadows	Meadowtown Exchange	Bus exchange	TransLink
Port Coquitlam	Port Coquitlam Station	Station	TransLink
Port Moody	Port Moody Station	Station	TransLink
Richmond	Aberdeen Station	Station	TransLink
Richmond	Bridgeport Station	Station	TransLink
Richmond	Lansdowne Station	Station	TransLink
Richmond	Richmond–Brighouse Station	Station	TransLink
Richmond	Sea Island Station	Station	TransLink
Richmond	Templeton Station	Station	TransLink
Richmond	YVR–Airport Station	Station	TransLink
Surrey	East Guildford Park & Ride	Bus exchange	TransLink
Surrey	Gateway Station	Station	TransLink
Surrey	Guildford Exchange	Bus exchange	TransLink
Surrey	King George Station	Station	TransLink

Level 3 destinations – Transit Stations and Exchanges (Cont'd)

Municipality	Destination Name	Distance Measured To	Basis for Inclusion
Surrey	Newton Exchange	Bus exchange	TransLink
Surrey	Scott Road Station	Station	TransLink
Surrey	Scottsdale Exchange	Bus exchange	TransLink
Surrey	South Surrey Park & Ride	Bus exchange	TransLink
UBC	UBC Exchange	Bus exchange	TransLink
Vancouver	29th Avenue Station	Station	TransLink
Vancouver	Broadway–City Hall Station	Station	TransLink
Vancouver	Burrard Station	Station	TransLink
Vancouver	Commercial–Broadway Station	Station	TransLink
Vancouver	Granville Station	Station	TransLink
Vancouver	Joyce–Collingwood Station	Station	TransLink
Vancouver	King Edward Station	Station	TransLink
Vancouver	Kootenay Loop	Bus exchange	TransLink
Vancouver	Langara–49th Station	Station	TransLink
Vancouver	Marine Drive Station	Station	TransLink
Vancouver	Marpole Loop	Bus exchange	TransLink
Vancouver	Nanaimo Station	Station	TransLink
Vancouver	Oakridge–41st Station	Station	TransLink
Vancouver	Olympic Village Station	Station	TransLink
Vancouver	Pacific Central Station	Station	Via Rail
Vancouver	Renfrew Station	Station	TransLink
Vancouver	Rupert Station	Station	TransLink
Vancouver	Stadium–Chinatown Station	Station	TransLink
Vancouver	Stanley Park Loop	Bus exchange	TransLink
Vancouver	Waterfront Station	Station	TransLink
Vancouver	VCC–Clark Station	Station	TransLink
Vancouver	Yaletown–Roundhouse Station	Station	TransLink

Level 3 destinations – Gateways

Municipality	Destination Name	Distance Measured To	Basis for Inclusion
Delta	Boundary Bay Airport	Airport building	n/a
Delta	Point Roberts Border Crossing	Cyclist crossing point	n/a
Delta	Tsawwassen Ferry Terminal	Cyclist ticket purchase point	n/a
Langley Township	Aldergrove Border Crossing	Cyclist crossing point	n/a
Langley Township	Langley Airport	Airport building	n/a
Pitt Meadows	Pitt Meadows Airport	Airport building	n/a
Richmond	YVR–Vancouver Airport	Airport building	n/a
Surrey	Douglas Border Crossing	Cyclist crossing point	n/a
Surrey	Pacific Border Crossing	Cyclist crossing point	n/a
West Vancouver	Horsehoe Bay Ferry Terminal	Cyclist ticket purchase point	n/a

Level 3 destinations – Centres outside Metro Vancouver

Municipality	Destination Name	Distance Measured To	Basis for Inclusion
Abbotsford	Abbotsford	Municipal boundary	n/a
Mission	Mission	Municipal boundary	n/a
USA	Blaine	Municipal boundary	n/a
USA	Bellingham	Municipal boundary	n/a
USA	Point Roberts	Municipal boundary	n/a
Squamish–Lillooet Region	Britannia Beach	Municipal boundary	n/a

Level 3 destinations – Post-Secondary Education

Municipality	Destination Name	Distance Measured To	Basis for Inclusion
Burnaby	BCIT	Cyclist entry point	Regional
Burnaby	SFU	Cyclist entry point	Level 1 – Urban Centre
Langley Township	Trinity Western University	Cyclist entry point	Regional
Surrey	SFU Surrey	Cyclist entry point	Regional
UBC	UBC	Cyclist entry point	Level 1 – Urban Centre
Various	Douglas College	Cyclist entry point	Regional
Various	Kwantlen Polytechnic University	Cyclist entry point	Regional
Various	Langara College	Cyclist entry point	Regional

Level 3 destinations – Major Tourism

Municipality	Destination Name	Distance Measured To	Basis for Inclusion
Burnaby	Burnaby Museum and Carousel	Cyclist entry point	Tourism Vancouver
Electoral Area A	Museum of Anthropology	Cyclist entry point	Tourism Vancouver
Langley Township	Fort Langley National Historic Site	Cyclist entry point	Tourism Vancouver
Langley Township	Greater Vancouver Zoo	Cyclist entry point	Tourism Vancouver
Langley Township	Langley Events Centre	Cyclist entry point	Tourism Vancouver
Maple Ridge	Davidson Pool	Cyclist entry point	Municipality
Maple Ridge	Haney House	Cyclist entry point	Municipality
Maple Ridge	Maple Ridge Library	Cyclist entry point	Municipality
Maple Ridge	Maple Ridge Museum	Cyclist entry point	Municipality
Maple Ridge	Maple Ridge Municipal Hall	Cyclist entry point	Municipality
Maple Ridge	The ACT	Cyclist entry point	Municipality
Maple Ridge	Town Centre Swimming Pool	Cyclist entry point	Municipality
North Vancouver City	Lonsdale Quay	Cyclist entry point	Municipality
North Vancouver City	Maplewood Farms	Cyclist entry point	Tourism Vancouver
North Vancouver District	Capilano Suspension Bridge	Cyclist entry point	Tourism Vancouver
North Vancouver District	Grouse Mountain	Cyclist entry point	Tourism Vancouver
Surrey	Cloverdale Fairground	Cyclist entry point	Tourism Vancouver
Surrey	Surrey Arts Centre	Cyclist entry point	Municipality
Surrey	Surrey Museum	Cyclist entry point	Municipality
Surrey	Surrey Nature Centre	Cyclist entry point	Municipality
Vancouver	Bloedel Conservatory	Cyclist entry point	Tourism Vancouver
Vancouver	Dr Sun Yat–Sen Classical Chinese Garden	Cyclist entry point	Tourism Vancouver
Vancouver	Granville Island	Cyclist entry point	Tourism Vancouver
Vancouver	HR MacMillan Space Centre & Museum of Vancouver	Cyclist entry point	Tourism Vancouver
Vancouver	Science World	Cyclist entry point	Tourism Vancouver
Vancouver	Vancouver Art Gallery	Cyclist entry point	Tourism Vancouver
Vancouver	Vancouver Aquarium	Cyclist entry point	Tourism Vancouver
Vancouver	Van Dusen Gardens	Cyclist entry point	Tourism Vancouver

Appendix 2

Route Naming Advice

Benefits of route names

Naming a route provides the opportunity to create a memorable reference in the same way that a street name is a reference in an address.

Named routes can also provide an identity for the facility which is useful for promotion, for example on recreational routes.

Route names can help wayfinding but require additional location-specific details to enable someone to locate and orient themselves. To understand your exact location along a route, it would be necessary to either be at the intersection of two named routes or be able to see additional information such as a building name.

The form of the name is also important. Long or unfamiliar names can be difficult to remember. Names that can be related to or describe the facility are generally easier to recall and to place. Codes are a short form of name that can be more easily remembered and can be planned in a way that logically links routes in a network or hierarchy.

Choosing route names

A memorable name should ideally be:

Short

Single words, using simple familiar terms are more easily remembered and communicated. Long names often tend to be abbreviated which can lead to misunderstanding.

Relevant

Names that are connected with the character of the facility (for instance 'Pacific Coast Trail') or the area it passes through will be linked to memory and experience. However naming routes after streets can be confusing if the route switches to other streets along its length.

Durable

Names that are dedicated to special events can be durable especially if supported by other references.

Distinctive

Names that have an impact or cultural or social association can be memorable.

Appendix 3

Specific Applications

Any network will include many specific issues that must be tackled by cyclists and addressed by practitioners preparing wayfinding projects.

This section will provide advice on how to address a range of scenarios that require particular consideration for the safety, comfort and convenience of cyclists and other road users.

I	Route interruptions	88
II	Two-stage turn movements	90
III	Bike parking access	92
IV	Signing non-intuitive routes	94
V	Multiple directional choices	96
VI	Two-way to one-way transitions	98
VII	Multi-use path crossings	100
VIII	Transitions from on-street to multi-use paths	102

I Route interruptions

Designated cycling routes are sometimes interrupted by segments that do not meet TAC guidelines and which are not signed and marked as designated cycling facilities. In such cases, there are a number of steps that can be taken to safely guide cyclists through.

Wherever possible a designated facility including wayfinding signage and markings should be established around the interruption until the more direct route can be upgraded. In the meantime, where conditions are appropriate, waymarkers can be used to guide users to the designated route.

Regulatory Signs

Regulatory and warning signs such as "Bikes Yield to Pedestrians" may be needed; please refer to TAC Bikeway Traffic Control Guidelines for Canada for further guidance.

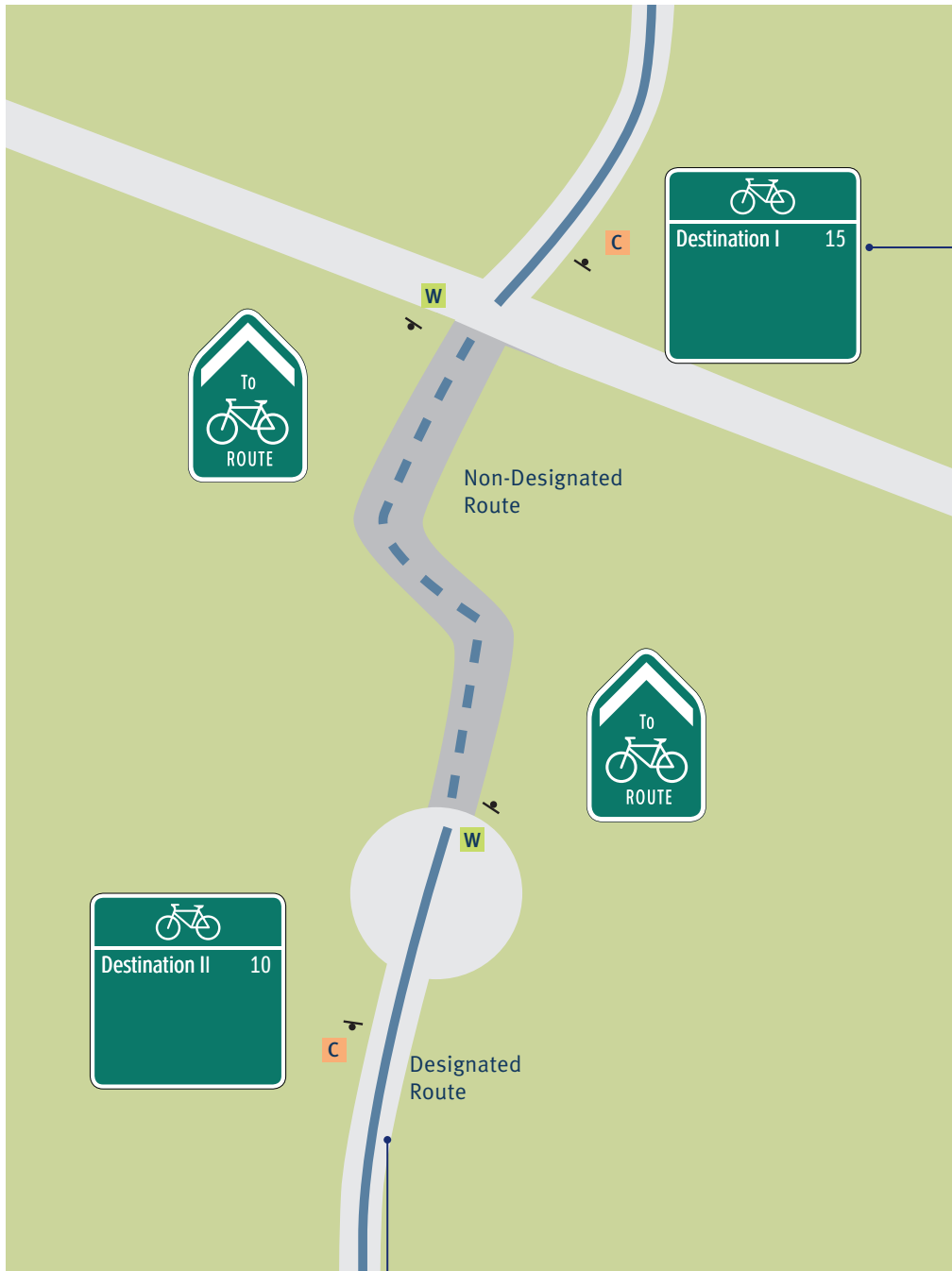

Confirmation signs are important to indicate when users have rejoined the designated route.

Only the designated route should be signed for wayfinding

II Two-stage turn movements

Historically cyclists have been encouraged to cross into the centre lane in order to execute a left hand turn. This manoeuvre can be intimidating for inexperienced cyclists and can place cyclists in conflict with motor vehicle traffic.

Two-stage turn boxes, by contrast, provide wayfinding guidance to cyclists so that they can avoid conflict with through traffic. The colour and markings act as a beacon, allowing cyclists to:

- **Position themselves at the front of the queue;**
- **Avoid conflicting with pedestrians in the crosswalk; and**
- **Get a head start on motor vehicles waiting to move across the intersection.**

Turn Box Marking

Consider the use of skid resistant, green* pavement coating with white bicycle and arrow markings to highlight the bicyclist priority within the box area.

Regulatory Signs

Regulatory signs such as Stop Line – Except Bicycles (tab sign), Bike Crossing, and No Right Turn on Red signs may be needed; please refer to TAC Bikeway Traffic Control Guidelines for Canada for further guidance.

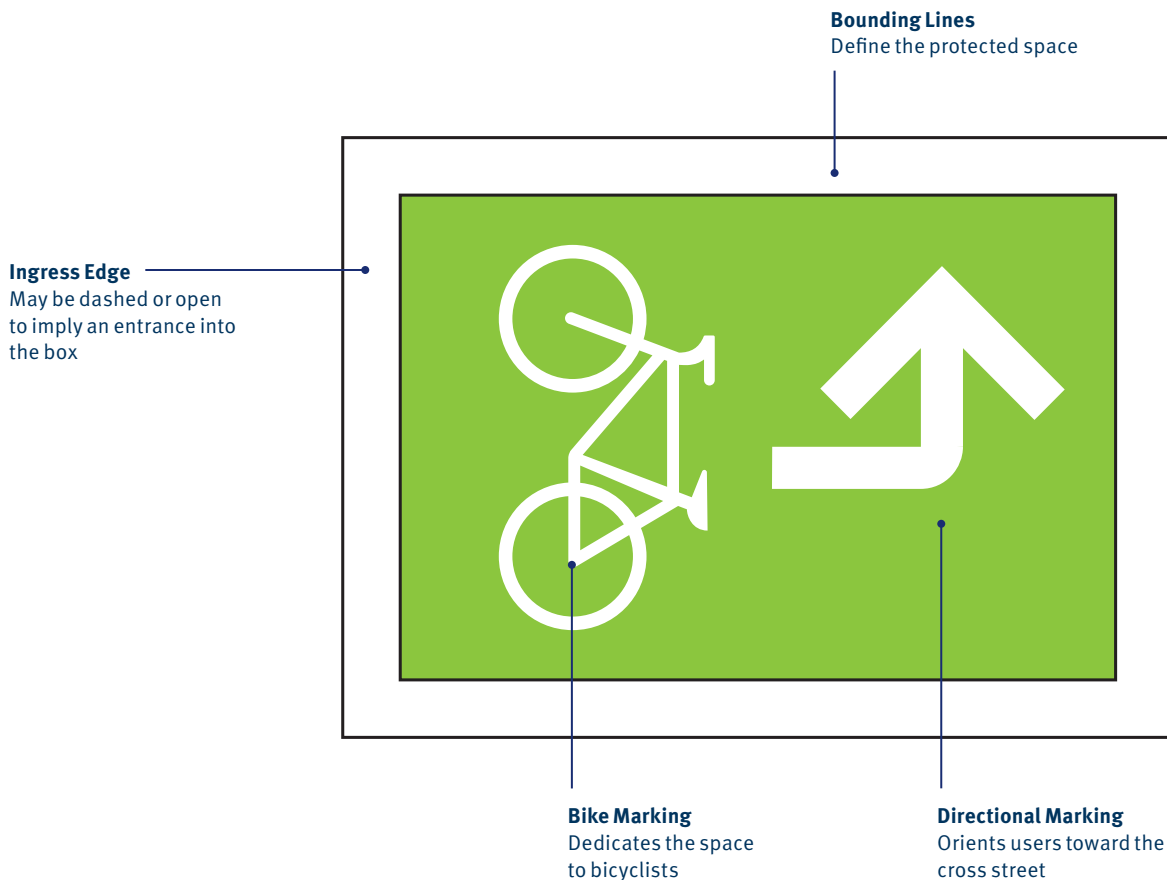

* TAC has reserved green as the optional color for bicycle lanes / bike boxes.



Bikeway design shown is to display typical signage requirements only, and is not intended to illustrate recommended bikeway design. Consult TAC Bikeway Traffic Control Guidelines and NACTO Urban Bikeway Design Guide for guidance, ensuring the design minimizes conflicts with right turns.

III Bicycle parking access

Accessing bicycle parking at a rapid transit station or exchange can be challenging due to potential conflicts with pedestrians and transit vehicles. This situation is complicated when the preferred route to access bike parking differs from that used by other modes to access the station. In such a situation, it is reasonable to include wayfinding specific to cyclists.

The following example illustrates how wayfinding can direct cyclists, helping them to avoid conflicts, using legible and coherent signage and markings.

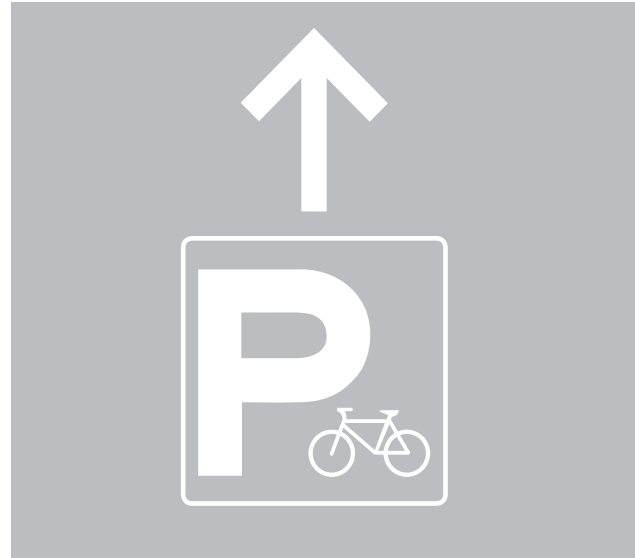

Directional Pavement Marking

In off-street settings this pavement marking can be used to direct cyclists and to help position them relative to pedestrian traffic



Multi-use Path Shared Space Marking

This pavement marking reminds users that the space is shared, and by placing the pedestrian above, encourages cyclists to yield to pedestrians.

Off-network Waymarking Sign
If destination is clearly visible, waymarking signs here may not be necessary.

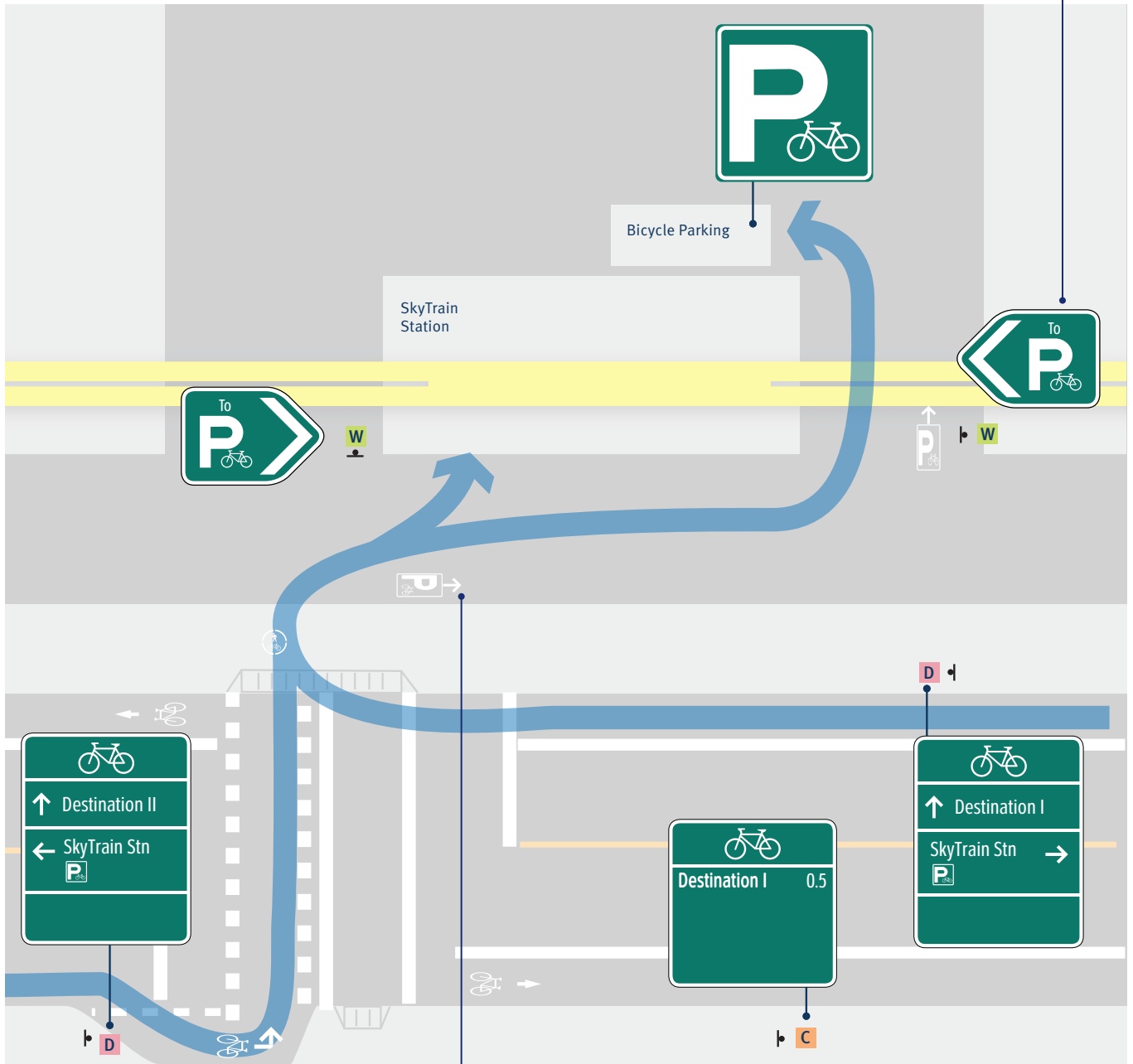

Station Area Wayfinding Marking
On station area access streets, directing users to parking

IV Signing non-intuitive routes

Multi-leg intersections can be difficult to sign, particularly if there is a destination associated with each connecting route.

An approach to this type of situation is to consider the area as an enlarged decision zone with specific turn decision points. This allows the general principal of progressive disclosure to be applied to sign contents.

The approach illustrated on the next page shows a complex intersection which has been signed as a decision zone, including diagrammatic decision signs and confirmation signs on the major routes into and from the area. Within the intersection, fingerboards are used to mark turning points for specific destinations.

In order to emphasize and clarify the wayfinding, this situation might also benefit from legibility treatments including the addition of green pavement, a painted line, pavement markings or a map.

The Turn Fingerboard indicating the turning point for Destination IV is provided because a Level 3 destination has been identified. However, because it is not a designated bike route, no further Decision or Confirmation Signs are recommended. This use of Turn Fingerboards should be limited to cases where the destination is close by and does not require additional turns after leaving the designated bike network. In the northbound direction, Off-network Waymarkers may be included to help cyclists find the designated bike network.

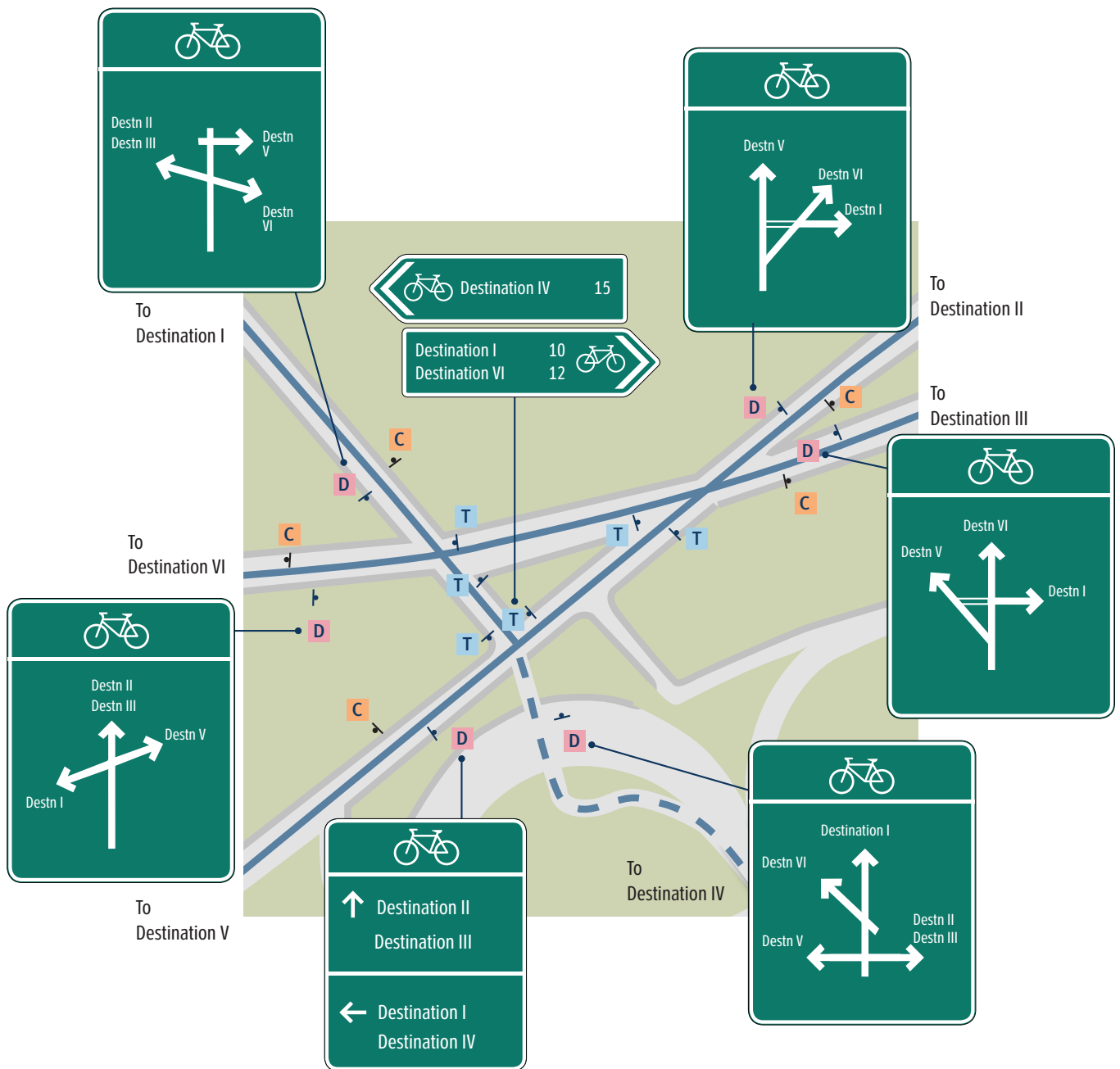

V Multiple direction choices to the same destination

At locations where there are multiple designated bike routes to the same destination, and the route choices differ only in comfort or directness, it is useful to describe these differences to cyclists at decision points. Recommended terms to distinguish routes include:

- **via scenic route**
- **via quiet route**
- **via direct route**

This information can be put on a secondary line, similar to “via” destinations.

It may not be necessary to describe conditions on both route choices if one condition can be inferred from the other. For example, if one direction is described as “via quiet route”, users can infer that the route in the other direction is busier, so no “via” line is needed for the busier route. This reduces the amount of text and makes the sign easier to read quickly.

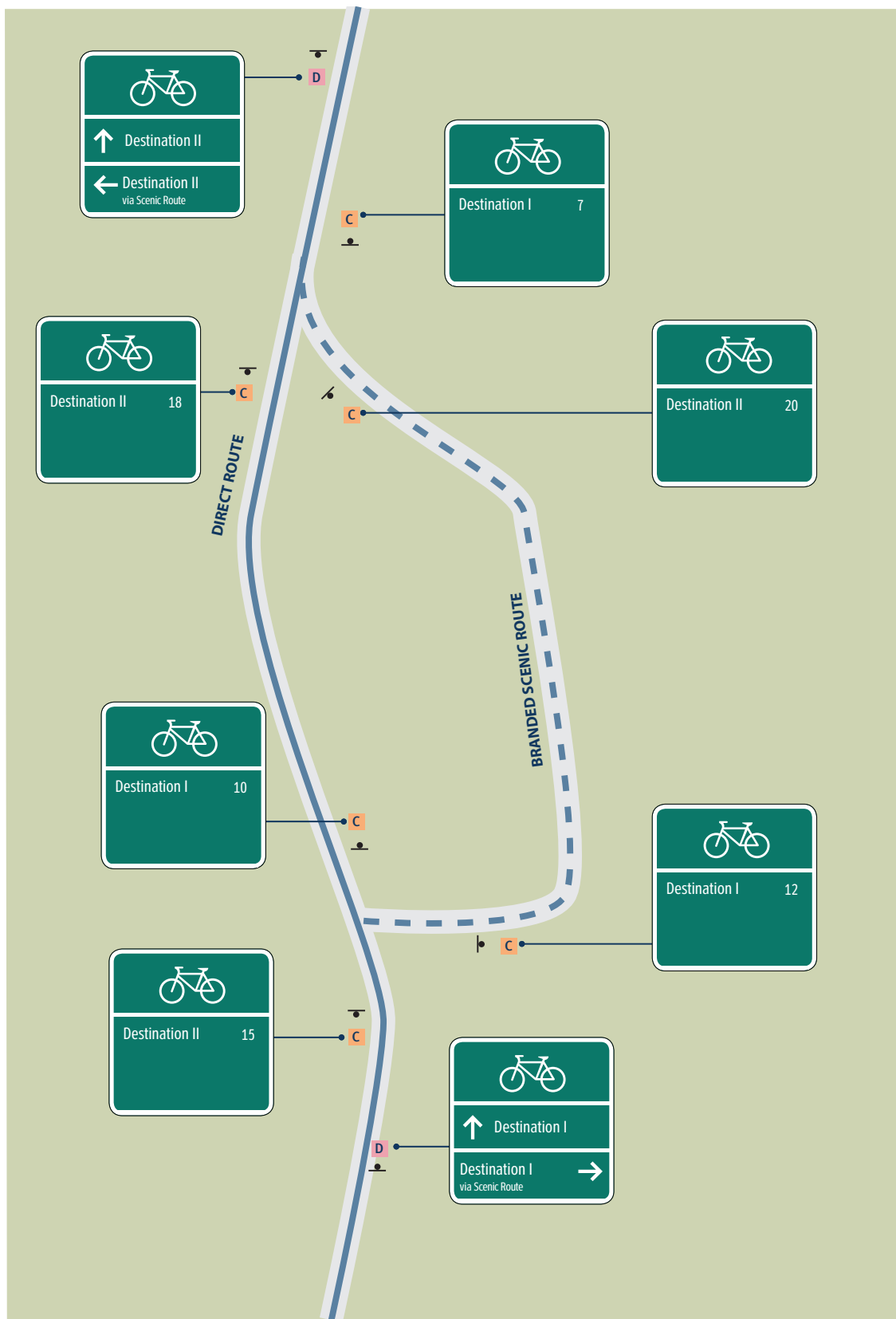

VI Two-way to one-way transitions

Transitions from a one-way to two-way facilities are becoming more common, yet wayfinding guidance through such situations is often lacking. This example offers a wayfinding approach to allow cyclists to transition safely and efficiently.

Transition at Signalized or Unsignalized Intersection

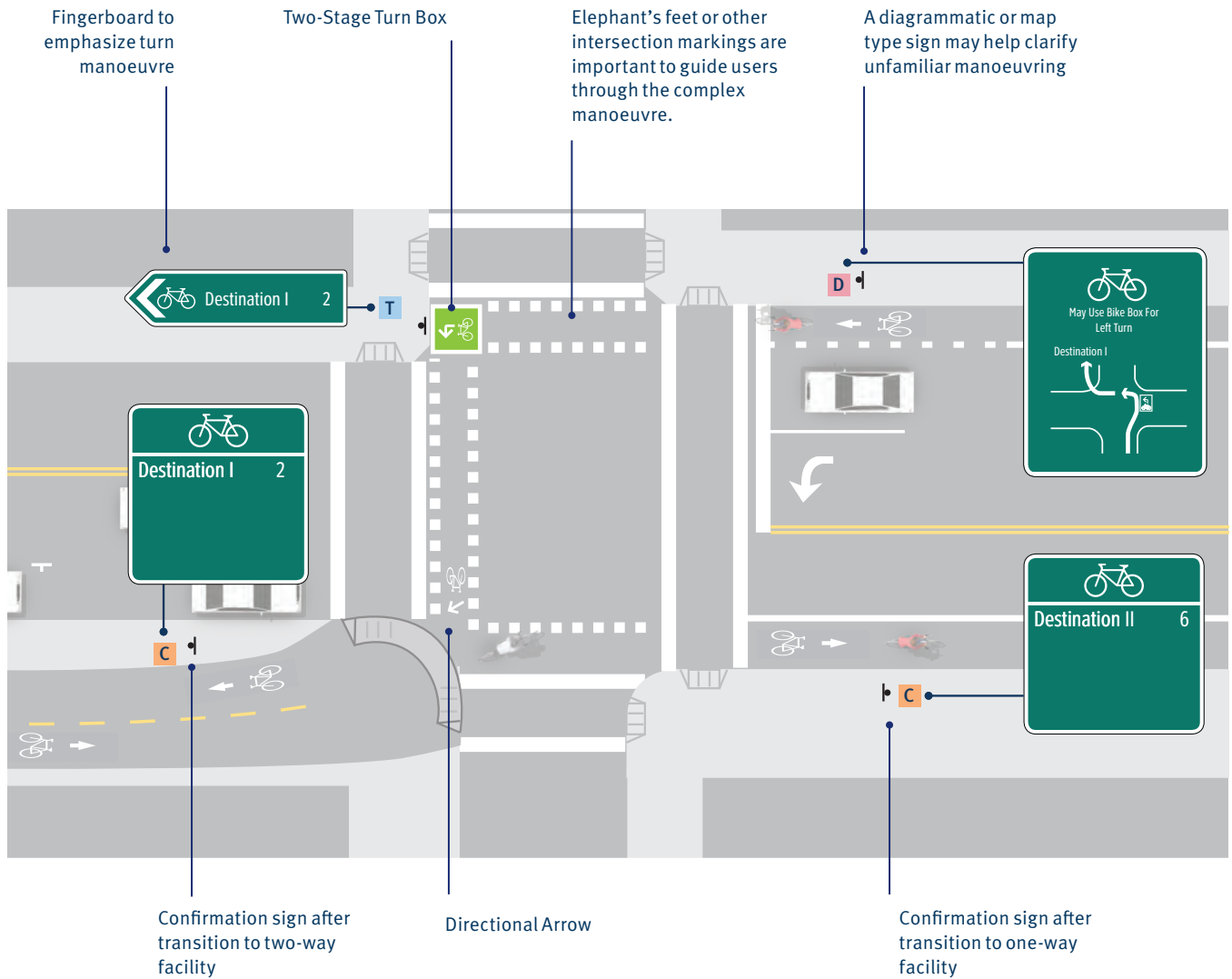

Parallel Multi-use Path Crossing

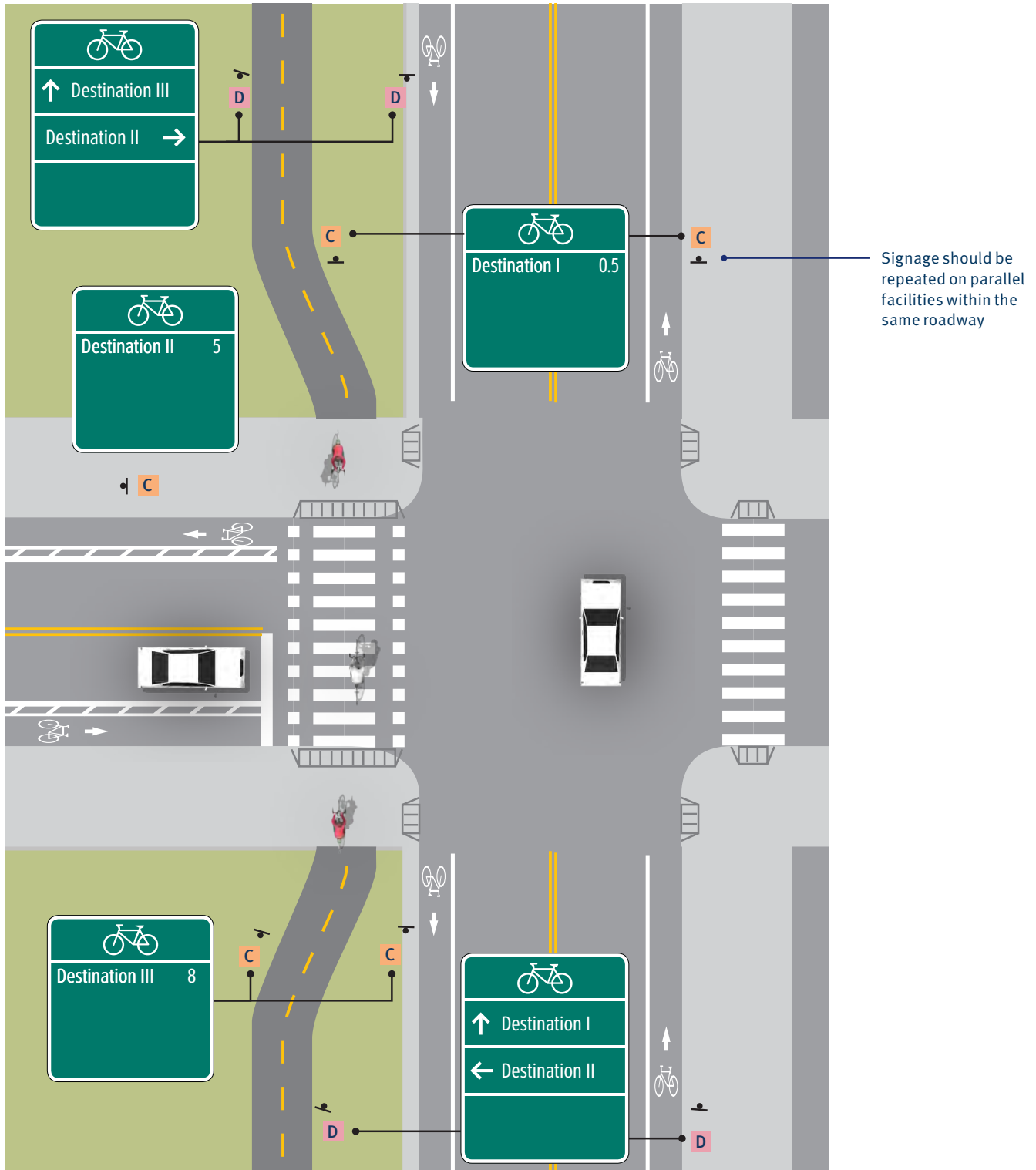

VIII Transitions from on-street to multi-use path

This diagram describes how to transition from an off-street path onto an on-street designated facility. Wayfinding signage and pavement markings are important in this instance not only to guide cyclists through the situation but also to make pedestrians and drivers aware of the potential presence of cyclists and their likely trajectory.

Careful attention to placement of wayfinding signage is needed to avoid misdirecting cyclists and to allow them to obtain needed information while avoiding conflict with motor vehicles and pedestrians.

Regulatory Signs

Regulatory signs such as Stop Line – Except Bicycles (tab sign), Bike Crossing, and No Right Turn on Red signs may be needed; please refer to TAC Bikeway Traffic Control Guidelines for Canada for further guidance.

Bicycle Boulevard

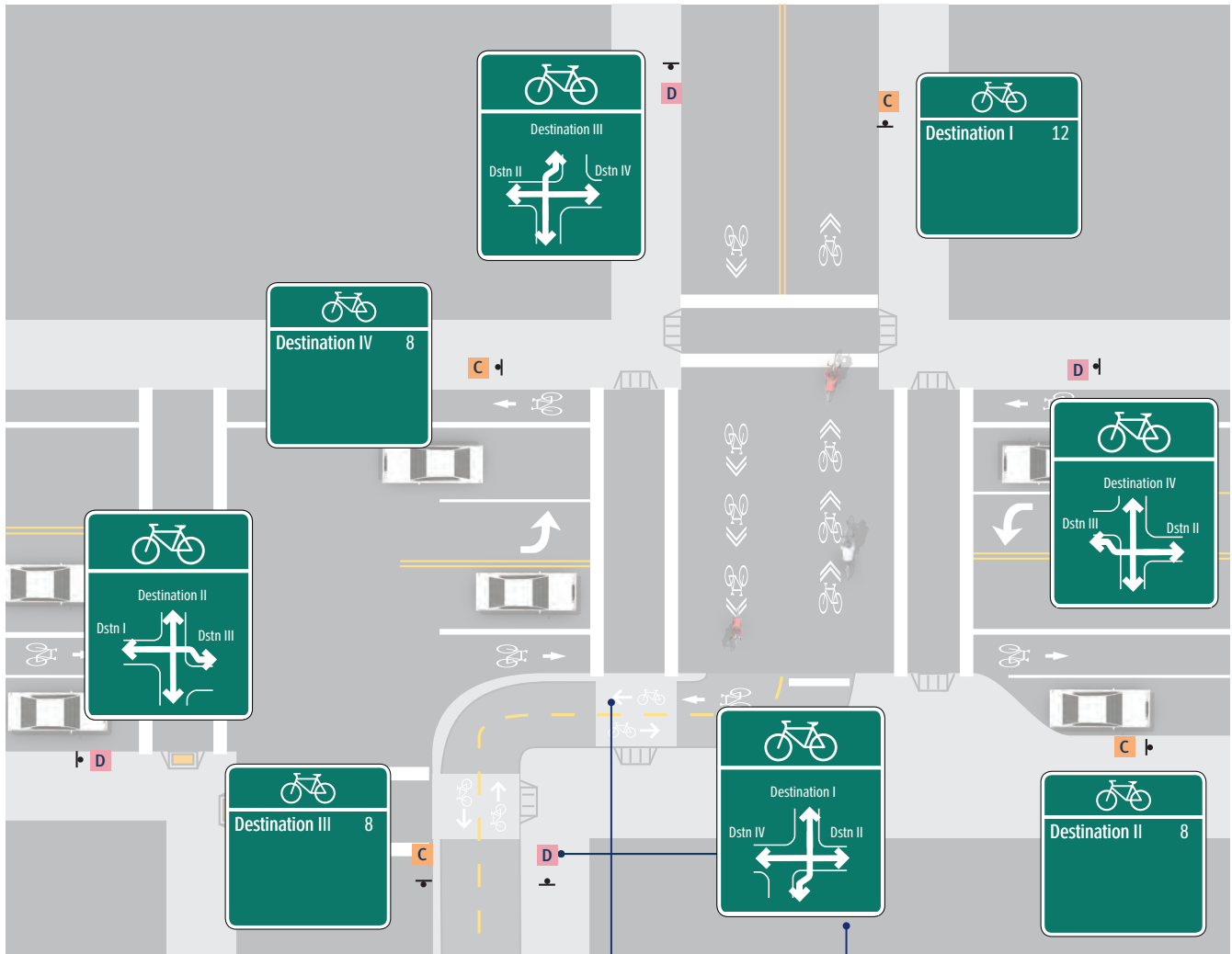

Marking pedestrian crossings with bike symbols warns pedestrians of crossing bicyclists

Diagrammatic sign for complex connections

Appendix 4

Summary of Bicycle Wayfinding Best Practice Review

1.0 Purpose and scope of review

1.3 Defining best practice examples

Best practice implies practice that has proven to be effective and is the best available. In the field of cycling, what determines effectiveness and success in one place may not transfer easily to another due to a range of legislative, physical and social factors. This review has looked broadly at the full range of issues related to wayfinding and cycling to arrive at a framework for regional guidelines but through the lens of what can be achieved within the national, provincial and regional context.

In the field of utility cycling, there is common agreement that Northern European cities including Copenhagen, Odense and Amsterdam are global benchmarks. While there are few areas in the world that can replicate the culture, geography and decades of investment behind their success, it is useful to consider the strategic approaches that have enabled cycling to remain major contributors to their city transportation systems over decades. It is possible to derive useful principals for cycling development from the policy frameworks of these historically cycling-friendly cities. A helpful policy summary has been produced by the European Union (below).

PRESTO Cycling Policy Guide for Infrastructure

What is it that makes cyclists want to get on their bikes? Starting from user needs, it is possible to define five main requirements for cycle-friendly infrastructure. These were developed in the Netherlands, but have been internationally recognized as valid policy guidelines.

Safe

Safety is undeniably the basic requirement and must be the overriding concern.

Direct

Directness means that the cyclist has as direct a route as possible to his destination.

Cohesive

[Network] Cohesion is about the extent to which cyclists can go from any origin to any destination without interruption.

Attractive

Attractiveness means that bicycle infrastructure is well integrated into agreeable surroundings.

Comfortable

Comfort is about creating an enjoyable, smooth and relaxed cycling experience.

At a more specific level, the guiding frameworks for highway signage produced by TAC with its close associations with the US FHWA, mean that where good practice is found in North America it is likely that it can be directly transferred to Metro Vancouver. Minneapolis and Portland have the largest cycling mode share of major US cities. Portland has a system of wayfinding that can provide examples to Metro Vancouver, while Minneapolis has concentrated on innovation in other areas of bike provision.

At a national level, the city of Victoria leads the way in cycling mode share. While Victoria is exemplary, its success is often attributed to its compact size, topology and student populations and is hence less relevant to Metro Vancouver. Successful cycling cities do not necessarily offer best practice in all areas of bike planning and engineering. Looking beyond the cities with the most cyclists there are good examples where wayfinding strategies, guidelines and practices have been prepared as part of recent cycling growth plans.

Cities such as Oakland (California), Chicago and San Francisco have published wayfinding guidelines that contain good ideas and are largely transferable. Further afield cities including London, UK and Sydney, Australia have also produced standards for bicycle wayfinding that while not directly transferable, provide solid planning approaches and useful problem-solving ideas that can be adapted to Metro Vancouver.

The EU PRESTO guide provides a general framework for cities developing cycling. It describes the components of a quality experience which can be referred to when setting up wayfinding principles.

2.0 Wayfinding benefits and principles

This section describes the importance of wayfinding to cities preparing bike plans and the principles of good wayfinding.

2.1 Role of wayfinding

Bicycle wayfinding systems are often recognized as having an important role in facilitating and improving cycling.

Action 1A.4 of the **City of Oakland's** Bicycle Master Plan (2007) states,
 “Route Signage: Develop an informative and visible signage system for the bikeway network, building on existing bikeway signage, that includes directional and distance information to major destinations.”

Austroads (Australia) Guide to Traffic Engineering Practice – Part 14 – Bicycles (1999)
 9.4 Guide Signs
 Guide signs are very important to cyclists as they define the route and provide necessary information to enable cyclists to conveniently find their way around the network.

The primary objectives of the Network component of the Toronto Bike Plan will have the **City of Toronto**:
 Complete the bikeway network in 10 years;
 Ensure the safe and comfortable year round operation of bikeways through design, signage, enforcement and maintenance; and
 Connect Toronto's network to bikeways in adjacent municipalities.

Each of these above examples, includes a statement of intent for wayfinding. They all state how introducing wayfinding will assist the overall goals for cycling in a similar way to 'Cycling for Everyone'.

2.2 Wayfinding principles

Wayfinding is a complex, normally subconscious process undertaken by any traveller irrespective of mode. Wayfinding processes are more obvious when we are visitors or when first using a mode of travel. How we identify where we are, the directions we should take and what we remember are all wayfinding processes that can benefit from simple, consistent and reliable information.

Information for cycling has particular challenges related to the needs of users and the nature of cycling as a mode:

1. User needs – It is a strategic regional aim to stimulate a shift from driving as the majority mode of travel, to transit by walking and cycling¹. This suggests an increase in new people taking to cycling and not simply encouraging existing cyclists to ride more. People are wary of travel by bicycle as it is a mode of transport powered by the user. Anxiety about getting lost, becoming tired and journey times can lead to a decrease in confidence in cycling as a reliable mode of transport. Presenting information for cycling in a structured and consistent manner will enable users to understand the network and plan new cycle journeys themselves, thus providing users with the tools necessary to make a change of mode with confidence.

2. Cycling dynamics – The way cycling works in a city is highly influenced by speed and journey purpose. A commuter travelling at a comfortable speed can easily keep pace with other traffic in the city centre. This suggests simple and clear wayfinding needs similar to vehicular traffic.

However, a leisure cyclist may ride slowly, stop frequently and change routes in a manner similar to walking. This suggests an ability to absorb more detailed wayfinding information such as maps.

Clearly both utility and leisure cyclists must be considered when planning information and these considerations help to establish the core principles for the wayfinding system as other cities have done.

¹ Goal 2 of A Transport Strategy for Metro Vancouver, 'Transport 2040', TransLink, July 2008

3.0 Information planning

Information planning is an essential process for successful wayfinding design – it establishes and sets out the parameters for what information needs to be provided, and where the information should be located. Knowing the type and location of information required directly influences the design of the signage.

This section describes these fundamental decisions for the Metro Vancouver wayfinding guidelines.

3.1 Places and destinations

Any wayfinding system requires an agreement about the places and destinations that will be included.

For the purposes of planning; a place can be described as an area of activity such as a downtown or shopping centre, while a destination is a specific location such as a hospital or school. In general, places have a wider appeal than destinations, although there are exceptions such a transport facilities which may be destinations of regional importance.

Establishing a hierarchy of places and destinations in the region and locally, enables wayfinding signs to be planned according to a logical progression of directions.

In Oakland, CA¹ three classes of destination are used in simple rules for sign composition, “.. *primary destinations are signed at distances of up to five miles; secondary destinations at distances up to two miles; and tertiary destinations at distances up to one mile.*”

This illustration shows the distribution of supported destinations in Oakland. This could be replicated in Metro Vancouver by mapping the regional centres identified in the 2040 Regional Growth Strategy and supplemented by consensus on other locations such as transit facilities and neighbourhood centres.

The process of identifying a hierarchy of places and destinations is also useful in terms of network planning. Cycling for Everyone has proposed a Major Bike Network as a core system that will link regional centres across Metro Vancouver.



Map of the City of Oakland, CA Supported Destinations

1. Design Guidelines for Bicycle Wayfinding Signage, para 2, page 7, Oakland, California

3.2 Route hierarchies

Establishing a comprehensive route network is an important aspect in building the confidence of potential and existing cyclists.

The bicycle route network may consist of strategic routes that connect regionally important places, municipal and cross-boundary routes linking local destinations, and other routes that are designed mostly for recreational use.

Dividing the network into a hierarchy related to how important each route is in terms of its connection to places and destinations, gives a framework for priority routing and where directional signs would be most useful. A hierarchical approach hence simplifies the network for the user and reduces potential sign clutter.

It is also important to distinguish this planning tool from other hierarchies used to describe likely conditions for users such as those used for the regional cycling maps and in 'Cycling for Everyone'

PRESTO Cycling Policy Guide for Infrastructure (shown below)

Describes three levels of route:

- Main Routes – Have a connecting function. They connect centres, villages, towns and cities with each other outside of the built-up area
- Top Local Routes – Have a distributor function. They provide the main cycling connections between urban districts and major urban areas.
- Local Routes – Have an access function. They include every street or track that can be used by cyclists, connecting all buildings and other origins and destinations to higher level routes.

Halifax's Active Transportation (AT) describes two levels of route:

- A primary "spine system" which consists of routes designed to be direct and that support cycling for commuting purposes; and,
- The secondary "community system" that connects local destinations such as schools, community centres, residential areas, local stores, commercial nodes, parks and recreational areas.

The City of Sydney, Australia uses three levels of route:

- Regional cycle routes forming the spine of the network from which local cycle routes radiate. They provide connections between areas of high population density and major activity centres, such as public transport nodes, universities, schools, shopping or commercial centres.
- Local cycle routes provide high quality connectivity to residential streets and local trip-generating facilities such as schools, bus and train interchanges, pools, libraries and shops.
- Tourism and recreational cycle routes provide recreational and tourist cycle access within the city or across regions. Examples of this type of route are rail trails (built along disused rail corridors), harbourside pathways and historical trails.

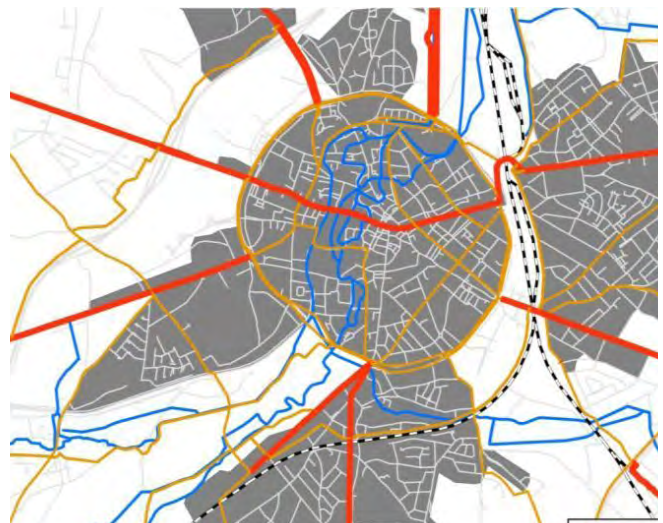

Right, the PRESTO model for a three-tier route hierarchy

3.4 Information typologies

In wayfinding, a typology describes the range of signs required and other information needed to maintain a consistent system. The TAC ‘Manual of Uniform Traffic Control Devices for Canada’ (MUTCDC) describes several levels of typology. At the highest level signs and markings are grouped by function into regulatory, warning, guide and information signs. Each of these groups is then further divided by application into for example: warning signs for road alignment, intersections, road features, transitions, regulations ahead and intermittent hazards.

Guide sign information is presented at pages 38–42 of the 2012 TAC guidance but does not cover destination signage.

There are good examples of wayfinding typologies from other countries in Europe and from Australia where destination signage is more common, but these are not easily replicated to meet general MUTCDC standards. However in recent years, cities in North America have begun experimenting with destination signage that offers useful reference for further development in the RBWG.

A basic wayfinding typology would follow the decision process for a moving turn on a main route. This can be divided into three main stages:

1. **Advance turn** – Warning of an upcoming decision point allowing the cyclist to get into position or to slow down
2. **Turn sign** – A direction marking the point of the turn, and
3. **Confirmation** – Reassuring cyclists of their current heading, upcoming destinations and details such as distances and services.

For simple turns and low volume routes this process can be simplified to two signs that could be added to the information typology:

4. **A Combined turn sign** which would replace the advance turn and mark the turn and destination and,
5. **Route markers** spaced at regular intervals replacing sign 3.

The examples (right) offer a selection of good references for these sign types:

Signs 1 to 3 (Oakland, CA) use simple clear information design, although the use of tab signs can be subject of increased maintenance.

Sign 4a (Chicago) uses finger blades that can be shaped to indicate direction at a glance and again show a simple, clear approach to design. Sign 4b (Portland) is more complex but direction is indicated by patch shape as well as arrow.

Sign 5 provides a bold trailblazer using a route code and with an indication of direction. This could be used as a pavement marking and, as a sign, could be supplemented with a destination line.

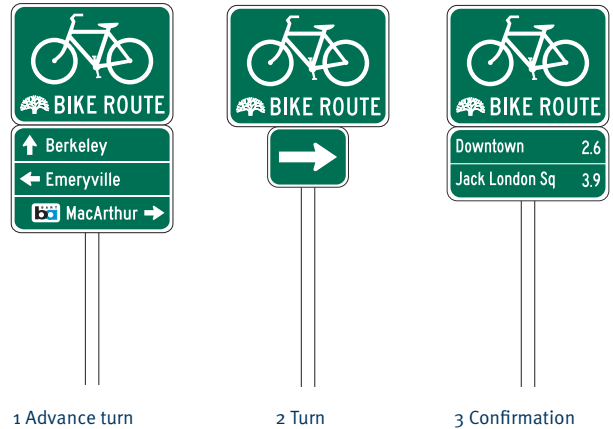

1 Advance turn

2 Turn

3 Confirmation



4a Combined turn

4b Combined turn

5 Route marker

4.0 Content design

Content design refers to specifications and guidance on how to arrange text, icons and other elements of information so that the sign is clear, consistent and legible. Content design is often influenced by standards for acceptable colours, sign shapes and typefaces. There are however design decisions related to text height, sign sizes and layout.

4.1 Existing sign and marking design standards

National guidance restricts some aspects of the design of signs and markings to maintain uniformity and to reflect research. The main reason for standards is to ensure drivers are not confused and therefore put at risk.

Standard elements described by TAC guidelines include:

- Sign shape (including some international conventions such as STOP sign shape – see below)
- Sign size (generally 300 x 450 mm rising in 150 mm increments)
- Colour of backgrounds, borders and text
- Typeface
- Type size
- Symbols (including arrow shapes)
- Elongation ratio for markings

In most cases these standards cannot be varied significantly. However the TAC guidance does not restrict experimentation where there are specific needs. As bicycle wayfinding is not comprehensively covered by the MUTCDC it is reasonable to propose adaptations of TAC guidance where examples from other countries might provide a useful solution.

4.2 Sign types

TAC guidance for bike signs is derived from standard approaches to driver signs. This provides a consistency in the overall typology but does not necessarily reflect the differences between cycling and driving, which fall into two key areas:

- 1) Cycling requires physical effort, so uninterrupted motion and avoiding wrong turns is more important.
- 2) A cyclist's field of vision is different to that of a driver.

These two factors suggest the value of repeated information in complex situations and information that is placed on a different plane to normal highway signs.

Practice from other cities provides examples for how to repeat information and place in it cyclists view without excessive signage cost or clutter.

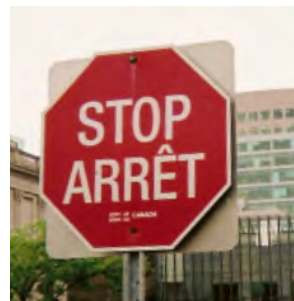

Above left: Simple waymarker decals confirm route heading (UK)
Above right: Repeater plates used to confirm heading and usage at a crossing. (UK)



Left: Pavement markings in Portland, are in the view of a cyclist looking for road hazards

4.3 Text

Typeface – The BC Ministry of Transportation and Infrastructure adopted the Clearview font family for all highway signage in 2006 (Technical Circular T-15/06). Clearview was developed by the US FHWA and has been proven to be more legible than the traditional FHWA Series E (Highway Gothic) typeface.

Text size– The size of text on signs is not described in TAC or BC MoTI guidance. Text size is instead part of standard sign templates and scaled according to overall sign size.

The normal size for a bike sign is 300 x 450 mm which is derived from standard driver sign sizes on the advice that drivers should also be able to read the bicycle signs. As a result of this, the BC MoTI propose smaller signs sizes and hence smaller text size, on off-street routes.

All of this guidance is however focused on warning and regulatory signs. Wayfinding signs tend to include more text and may be particular to certain modes. Examples from other cities show great variability in wayfinding text and sign sizes (right)

Influences on text size – Cyclists may move at similar speeds to other traffic, especially in cities, but field of vision, manoeuvrability, braking and acceleration performance are quite different. The variability in rider strength, bike mechanics and other influences make calculating average stopping distances, as a means to determine text size, quite complex. Practice from

elsewhere does include design speeds but with little consensus as these two following examples (above, right) show.

Wisconsin Bicycle Facility Design Handbook

Bicycling speeds

In determining design speeds for bicycle facilities, it is important to consider the average speeds of typical bicyclists, as well as other likely users. Studies have shown that the normal range for casual bicyclists is between 7 and 15mph (11 and 24 km/h); the average speed is between 10 and 11mph (16 and 18 km/h).

Austroads

7.5.2 Bicycle Operating Speed

Bicycle operating speeds on paths are influenced by a combination of human and other factors. It is important to recognise that under appropriate conditions many fit cyclists can maintain relatively high speeds. Speeds in excess of 35 km/h can be maintained on the flat whilst speeds of over 50 km/h can be attained on moderate gradients. It is recommended that paths be designed for a speed of at least 30 km/h wherever possible.

Text height is a critical issue both for user comfort but also in relation to sign size and sign formatting. Good practice guides contain a variety of advice on this:

Advised Cap Heights

City of Sydney – 60 mm (Highway Gothic)

Transport for London – 30 mm or up to 50 mm when viewing distances are over 30m (UK Transport font)

AASHTO (driver signage) – 25 mm per 12m viewing distance (Clearview)

The review of practice indicates that each authority develops a locally relevant solution for the size of text based on assessments of local riding conditions and local standards. In a similar way the guidelines will propose a text size for bicycle wayfinding signs in Metro Vancouver.



Clearview Hwy (bottom) is more legible than standard FHWA typefaces under halation testing which simulates impaired vision.

4.4 Colour

Standard TAC guidance on wayfinding signs is that they should have a green background with white text. This colour combination is well-established and familiar to drivers.

Less common is a blue backgrounds which is permitted as an alternate where differentiation may help reduce confusion between adjacent signs. Brown is also used, but by convention is restricted to tourism signage. Border colours for all signs should match the text colour.

As already discussed, wayfinding information generally tries to communicate more complex messages than warning and regulation signs. Introducing codes through colour is an approach often seen in other countries and especially in Europe, to simplify route following.

Previous experience with BC MoTI on route guidance suggests that limited use of colour coding or patches may be acceptable for experimental purposes.

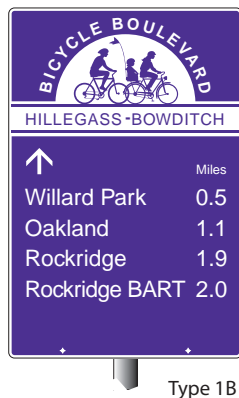

Type 1B

Examples of sign colourways. (clockwise from top left): Oakland, CA (standard green with coloured brand icon). Berkeley, CA (non-standard purple), Dallas, TX (sign in permitted variant blue), London, UK (coloured patch highlighting a regional route)



4.5 Icons

Standard icons are described in the TAC guidelines for common sign elements including arrows, the bicycle symbol, a reserved lane diamond and 'P' for parking,

Other possible icons to be included could be the TransLink network identifier 'T' denoting transit facilities as well as branding elements to denote sponsored or promoted routes. In the development of the icons a number of design aspects should be considered:

- Internationally recognized standards and North American standards e.g. American Institute of Graphic Arts references
- What is already used and is recognized in the region
- Legibility at relevant sizes across all applications (signs, maps, online)
- Visual 'fit' with other graphic elements
- Accessibility to differently able user groups
- Simplification where possible but not at the expense of meaning

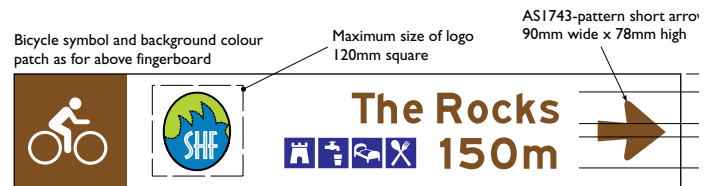

Above: Sign layout example from Sydney, Australia including a simple bike icon (used for pavement marking also), a route logo and icons to denote attractions and services.

Below: Icons used on Metro Vancouver trail signage including a standard SkyTrain icon and a non-standard walking icon



4.6 Diagrammatics

Diagrammatic signs are a permitted variant for freeway use in TAC. In some instances these may also be helpful to cyclists particularly if the path they should follow is through a complex intersection. Diagrammatic representations may also be useful in pavement markings, particularly if the route ahead is partially hidden.

There are examples from other jurisdictions, typically from Europe, where diagrammatic signs are more widely used as a way to communicate road networks that do not conform to a street grid.



Prototype diagrammatic route sign developed for the complex Winston Overpass intersection of the Central Valley Greenway and local Lakes bikeway in Burnaby, BC

4.7 Brand identity

Some routes have an identity that is communicated through naming, a customized design or as a result of sponsorship. There are a number of ways in which identity can be incorporated into signs or branded signs can be designed to include standard elements of wider systems.

As many branded routes are off-street there is a challenge to maintain consistency because MUTCDC guidance does not apply and designs may need to be negotiated with park boards or other authorities.



Above: A German bike sign incorporating branded routes (logos and names) along with standard local route information.

Below: Example of a fully custom designed sign system (North Shore Spirit Trail, Vancouver) including custom icons

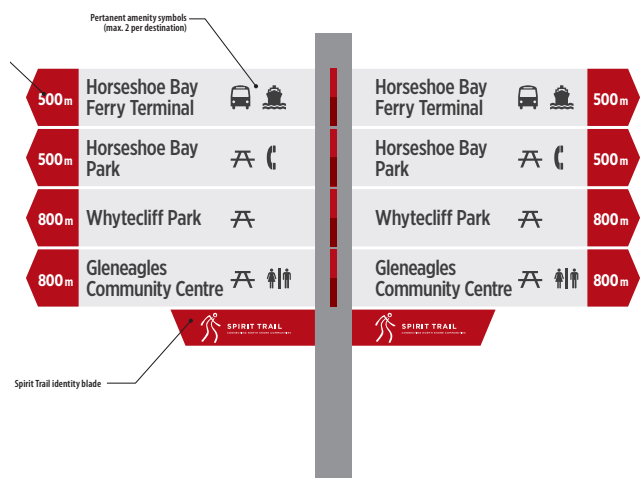

5.0 Implementation

This section examines examples and good practice on how wayfinding design is implemented and the sorts of guidance produced to assist practitioners to develop local wayfinding projects that fit into a regional information plan.

5.1 Reference to geometry and engineering

An important aspect of the guidelines will be assisting practitioners to interpret and apply the guidance to specific situations. For new bike routes, signage can be part of an engineering project and as a result, wayfinding will become part of normal planning and engineering. The Regional Bicycle Wayfinding Guidelines should be read in conjunction with other planning and traffic engineering practice and are not a substitute for engineering judgement and standards.

5.2 Local assessment

TAC guidance provides typical arrangement illustrations for the layout of signs and marking to support generic bike facilities. These do not however include wayfinding arrangements and the Regional Bicycle Wayfinding Guidelines will include both protocols and illustrative examples for the planning of wayfinding for typical situations.

Effective wayfinding relies on a consistent approach to all elements of information design, format and placement. Good practice provides examples of ways in which practitioners can evaluate what signs and markings are appropriate and how to schedule sign content for detailed design to ensure consistency in the wider network.

The available practice examples divide into three types:

Planning advice – The PRESTO policy guide from Europe provides strategic planning processes that help determine the status of a route in terms of its network value. This may assist some municipalities to assess local route hierarchies (see section 3 above) and hence the level and types of information that are appropriate.

Protocols – The City of Sydney describes a checklist of processes alongside normal planning and engineering that integrates wayfinding into a project solution. A protocol for assessing local wayfinding projects may be useful when drawing up local practice notes for internal use or to give to contractors.

Worked examples – NACTO provides a practice guide that illustrates typical solutions and draws out key aspects for assessment in similar situations. This may be particularly helpful in dealing with common hard-to-sign situations.

Level of signing	C1	C2	C3	C4
Type of route	High-speed, limited-access, regional routes usually paralleling State Roads or major regional roads	All other regional cycle routes	Local routes	Off-road, shared path and tourist/recreational routes
Advance direction signs	Yes, before route junctions with other C1 or C2 routes	Yes, at junctions where the route changes direction	No	No
Fingerboards at intersection	Yes, at route junctions with other C1 or C2 routes	Yes	Yes, integrated with street signage	Yes
Reassurance signs with distances	Yes, after route junctions with other C1 or C2 routes	Only if advance direction signs are not used	No	Route markers only
Route markers	No	No	Yes	Yes
Route numbering	Yes	No	No	No
Branding logos	Yes	Yes	No	Yes
Street signs	Yes, if none exist	Yes, if none exist	Yes, if none exist	Yes, if none exist

The City of Sydney Cycle Network Directional Signage Guidelines provides specific guidance for practitioners including the relationship between route hierarchy and level of signage shown above.

5.3 Legibility treatments

Legibility in environments is a measure of how easy it is to understand a place. Places with low legibility might have many decision points, unclear pathways, few landmarks or little memorable character. Often signage and markings are used to supplement legibility but it is also possible to address the basic issues directly and create a more legible place.

A legibility treatment can vary widely in scale and application. Examples might range from the simple application of a painted line to indicate preferred routing, to landscape and public art design projects provide area character or local landmarks.



Above: Changes in material can define routes

Left; UK National Cycle Network Mile Marker – these highly memorable beacons are dotted along the network at 5 mile intervals.



Below: A simple line can help mark a decision



5.4 Multi Use Paths

Multi Use Paths or Mixed Use Paths (MUPs) create particular issues for information and wayfinding across the world.

There are two separate issues that signs and markings are expected to resolve:

1. Modally-specific

Cyclists, horse riders, skaters and walkers might all share a single path. The approach speeds, different eye levels and different journey expectations create complex problems around content size, sign placement. Further complications and possible confusion are encountered when distances and destinations are included for different users.

2. Behaviour

An issue with some MUPs is the need to respond to real or perceived conflicts between the behaviour of path users. Cyclists travelling at inappropriate speeds, walkers without control of dogs (or children) and a lack of consideration by any user to those with limited mobility are all common issues. Information that incorporates a message about expected behaviour can be difficult to agree between advocacy groups and complicated to display effectively.

There are many examples of different approaches around the world and good practice appears to show that providing different types of information for different users and maintaining a balanced and positive tone of voice are most productive.



Left: Combining a lot of information on a sign aimed at different users can reduce legibility as a result of small text sizes and information overload.



Left: A simple pavement mark can remind users that the path is shared in support of other information.



RB-93



Above: Three approaches to shared use signs. The sign on the left is the TAC standard (RB-93). This sign explains status and no more. The middle, vandalized sign gives behavioural guidance but with rather abrupt language. The sign on the right (below) uses a polite tone of voice to request mutual respect. Tone of voice is an important consideration in achieving compliance.

5.5 Alternate routes

Alternate routes for cyclist may come about as a result of temporary need, such as to avoid construction, or because there are options, such as between a scenic or direct route. These require different approaches to wayfinding and would be included in the guidelines.

Temporary detours

The Bikeway Traffic Control Guidelines for Canada provides general guidance for signing an alternate route in the event that a cycling route is closed.

In many European jurisdictions they make considerable effort to maintain the continuity of cycling and walking routes, recognizing that cyclists and pedestrians are reluctant to detour. In some cases this can involve paving temporary ramps and delineating separate facilities to provide safe passage and reduce potential conflicts.



Temporary detour around a construction zone in Copenhagen

Route options

In order to find leading practice on means of directing cyclists to alternate routes, one need look no further than BC MoTI guidance.

The example below left shows signage on Highway 17 on the Saanich peninsula. This sign indicates two possible routes to access the Schwartz Bay ferry terminal; the first being Highway 17, the alternative being the Lockside Regional Trail. An option to this sign also indicates the distance to the alternate route so that cyclists are aware of the potential trade-off between a more direct route and the alternate. This approach offers the benefits of destination based signage and continues to assert the right of cyclists to use the more direct route.

The example below right shows a sign from Wales, UK along similar lines to the BC MoTI indicating an alternate scenic path, route coding and bi-lingual content.

Example of B-G-006 and tabs with distances



Example of Modified B-G-006 sign



Appendix 5

Template Guide



D1.4 Decision sign v1 130219
Wayfinding Guidelines for
Utility Cycling.ai /.dwg



D2 Decision sign v1 130219
Wayfinding Guidelines for
Utility Cycling.ai /.dwg



C1.3 Confirmation sign v1
130219 Wayfinding Guidelines
for Utility Cycling.ai /.dwg



C2 Confirmation sign v1 130219
Wayfinding Guidelines for Utility
Cycling.ai /.dwg



C2.1 Confirmation sign v1
130219 Wayfinding Guidelines
for Utility Cycling.ai /.dwg



C2.2 Confirmation sign v1 130219
Wayfinding Guidelines for Utility
Cycling.ai /.dwg

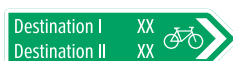

T1 Turn Fingerboard RIGHT v1
130219 Wayfinding Guidelines
for Utility Cycling.ai /.dwg



T1 Turn Fingerboard LEFT v1
130219 Wayfinding Guidelines
for Utility Cycling.ai /.dwg



W1 Off-Network Waymarkers v1
130219 Wayfinding Guidelines
for Utility Cycling.ai /.dwg

This Appendix contains information about the graphic templates that accompany Get There By Bike! Wayfinding Guidelines for Utility Cycling in Metro Vancouver.

The templates are intended as starting point to create the different layouts specified in Section 3 of Get There By Bike!

The templates, in Adobe Illustrator and CAD formats, are available upon request from wayfinding@translink.ca

Typeface

The typeface selected for the wayfinding sign designs is the Regular weight of ClearviewADA Condensed.

The font is designed by Terminal Design and is available from their website www.terminaldesign.com

All templates contain an uneditable outlined version of this typeface for reference on placement within the sign.

Typesize

Typesizes are specified within the template, beside the sign.

Sign colour

All signs should be standard white on a highway green base. The colours within the template are intended as a guide only.

Signs should be printed to colour specification provided by ASTM D4956, as recommended by the TAC Manual of Uniform Traffic Control Devices.

